

20TH-CENTURY BUILDING MATERIALS AND SUITABLE SUBSTITUTES

Windows Visual Guide

DEPARTMENT OF DEFENSE LEGACY RESOURCE MANAGEMENT PROGRAM

PROJECT 13-707

SAMANTHA DRISCOLL, EMMA DIEHL, PAM ANDERSON, A.D. MARBLE & COMPANY;
AND HEATHER MCDONALD ROBBINS, NAVAL FACILITIES ENGINEERING COMMAND, MID-ATLANTIC

Acknowledgements



This visual guide and associated report were funded by the DoD Legacy Resource Management Program in fiscal year 2013 (Legacy Project 13-707; Cooperative Agreement W9132T-13-2-0031). A.D. Marble & Company and Naval Facilities Engineering Command, Mid-Atlantic would like to acknowledge the following for their support and assistance in completing this project: Christopher Daniel, Fort Belvoir; Jason Huggan, Picatinny Arsenal; Susan Paul, NSA Bethesda; Kerry Vautrot, Portsmouth Naval Shipyard; Thomas Wright, NSF Indian Head; Julie Darsie, Naval Facilities Engineering Command, Washington, and the remaining Cultural Resources Managers and their designates throughout the Northeast and Mid-Atlantic regions who responded to our initial survey; Amanda Apple, Maryland Historical Trust; Scott Doyle, Pennsylvania Historical and Museum Commission; Marc Holma, Virginia Division of Historic Resources; Caroline Alderson and Claire Hosker, U.S. General Services Administration; Jennifer Groman, NASA; and Mimi Sadler, Sadler & Whitehead Architects.

*Cover page photos,
from left to right:*

“Lupton Steel
Pivoted Windows.” 1927.
David Lupton’s Sons Company,
Philadelphia, Pennsylvania.

[https://archive.org/details/
LuptonSteelPivotedWindows](https://archive.org/details/LuptonSteelPivotedWindows),
accessed April 2014.

“Description of Solid Wire
Glass.” 1918. Franklin Hodges
Company, Philadelphia,
Pennsylvania.

“Owens-Illinois
Insulux Glass Block 1943.” 1943.
Owens-Illinois Glass
Company, Toledo, Ohio.

DISCLAIMER: The contents of this report are not to be used for advertising, publication, or promotional purposes. Citation of trade names does not constitute an official endorsement or approval of the use of such commercial products. All product names and trademarks cited are the property of their respective owners. The findings of this report are not to be construed as an official Department of Defense position unless so designated by other authorized documents.

20TH-CENTURY BUILDING MATERIALS AND SUITABLE SUBSTITUTES

Windows Visual Guide

DEPARTMENT OF DEFENSE LEGACY RESOURCE MANAGEMENT PROGRAM
PROJECT 13-707

Prepared for:

DoD LEGACY RESOURCE MANAGEMENT PROGRAM
3400 DEFENSE PENTAGON
ROOM 5C646
WASHINGTON, D.C. 20301

Prepared by:

SAMANTHA DRISCOLL, EMMA DIEHL, PAM ANDERSON, A.D. MARBLE & COMPANY;
AND HEATHER MCDONALD ROBBINS, NAVAL FACILITIES ENGINEERING COMMAND, MID-ATLANTIC

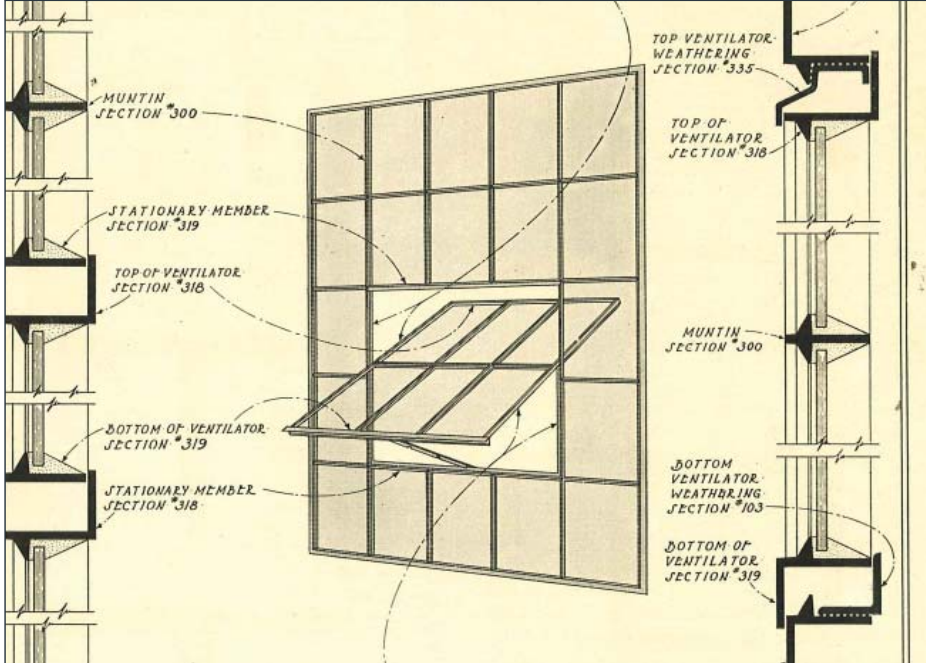
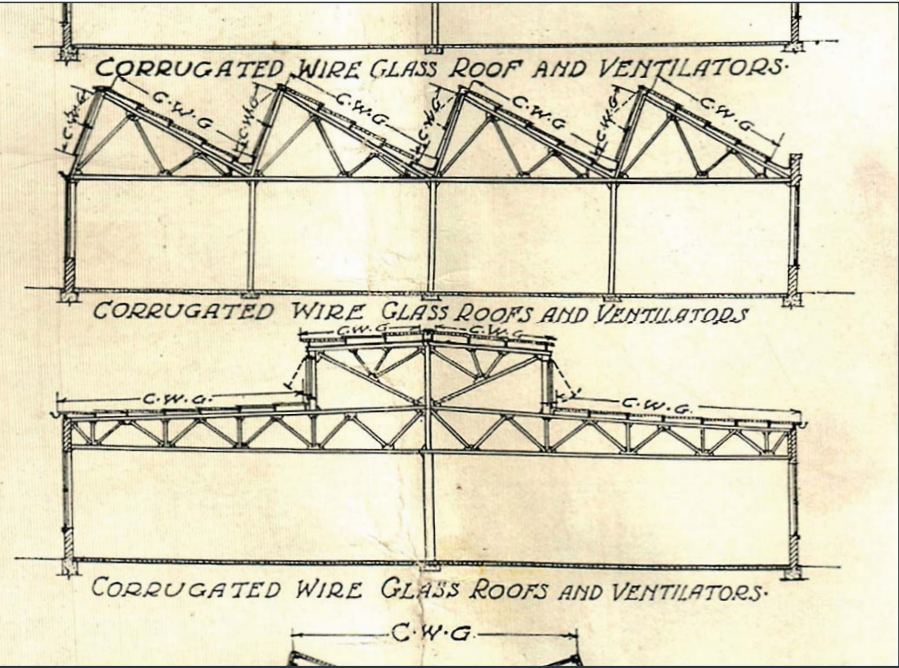

❖ TABLE *of* CONTENTS

ii-iii INTRODUCTION

1. STEEL WINDOWS

1-3 EXPLANATION OF MATERIAL
4 EXPLANATION OF CONSTRUCTION
5-9 EXAMPLES OF COMMON USE
10 REPLACEMENTS

2. CORRUGATED WIRE GLASS

11-12 EXPLANATION OF MATERIAL
13-14 EXPLANATION OF CONSTRUCTION
15-20 EXAMPLES OF COMMON USE

3. GLASS BLOCK

21-23 EXPLANATION OF MATERIAL
24-25 EXPLANATION OF CONSTRUCTION
26-30 EXAMPLES OF COMMON USE

31-38 ENDNOTES

39-41 BIBLIOGRAPHY

Opposite page photos:

Upper left – *Owens-Illinois Insulux Glass Block 1943*. 1943. Owens-Illinois Glass Company, Toledo, Ohio.

Upper right – “Corrugated Wire Glass For Industrial Buildings.” n.d. Hires Turner Glass Company, Philadelphia, Pennsylvania.

Lower left – Lupton Steel Pivoted Windows. 1927. David Lupton's Sons Company, Philadelphia, Pennsylvania.

Lower right – “Corrugated Wire Glass.” 1924. Hires Turner Glass Company, Philadelphia, Pennsylvania.

INTRODUCTION

The Department of Defense (DoD) inventory of early- to mid-twentieth-century buildings is facing a critical point in the serviceable lives of original windows - namely those constructed of steel, corrugated wire glass, and glass block. The *20th-Century Building Materials and Suitable Substitutes Windows Visual Guide* is designed as a quick-reference tool for Cultural Resource Managers (CRMs), facility planners, architects, and engineers entrusted with preservation, maintenance, and navigation of the Section 106 process of the National Historic Preservation Act while balancing project needs and regulatory requirements.

This Visual Guide is intended to provide the user with the ability to recognize and define steel, corrugated wire glass, and glass block windows as character-defining features in early- to mid-twentieth-century historic buildings (i.e., those buildings eligible for listing in or listed in the National Register of Historic Places, either individually or as part of a larger historic district). Each window type is explored to familiarize the user with the appearance of the material, construction methods applicable for identification or replacement, context of popular use, and *in-situ* examples in existing DoD architecture. The information and images in the Visual Guide are provided to assist the user in research, interpretation, and possible future mitigation.

The Visual Guide images reference the extensive research and investigation located in the *20th-Century Building Materials and Suitable Substitutes: Windows* Technical Report. Within Section 3.0, History of Twentieth-Century Window Types of the report, the materials and construction methods are compounded to include unique characteristics, development, and manufactures of each material to be utilized for future mitigation documentation. The common uses and examples simply scratch the surface of Section 6.0, Case Studies, which documents steel, corrugated wire glass, and glass block windows of individual DoD buildings across six installations with considerations for maintenance, preservation, replacement, regulation, and mitigation throughout the Section 106 process.

Windows are among the most prominent character-defining features of historic buildings, particularly those of the early to mid-twentieth century, and are also the most vulnerable to deterioration. Through recognition and context, the Visual Guide aims to familiarize CRMs with the distinctiveness and use of three predominant twentieth-century window types. Further information, examples, and guidance are available within the *20th-Century Building Materials and Suitable Substitutes: Windows* Technical Report.

STEEL WINDOWS

Explanation of Material

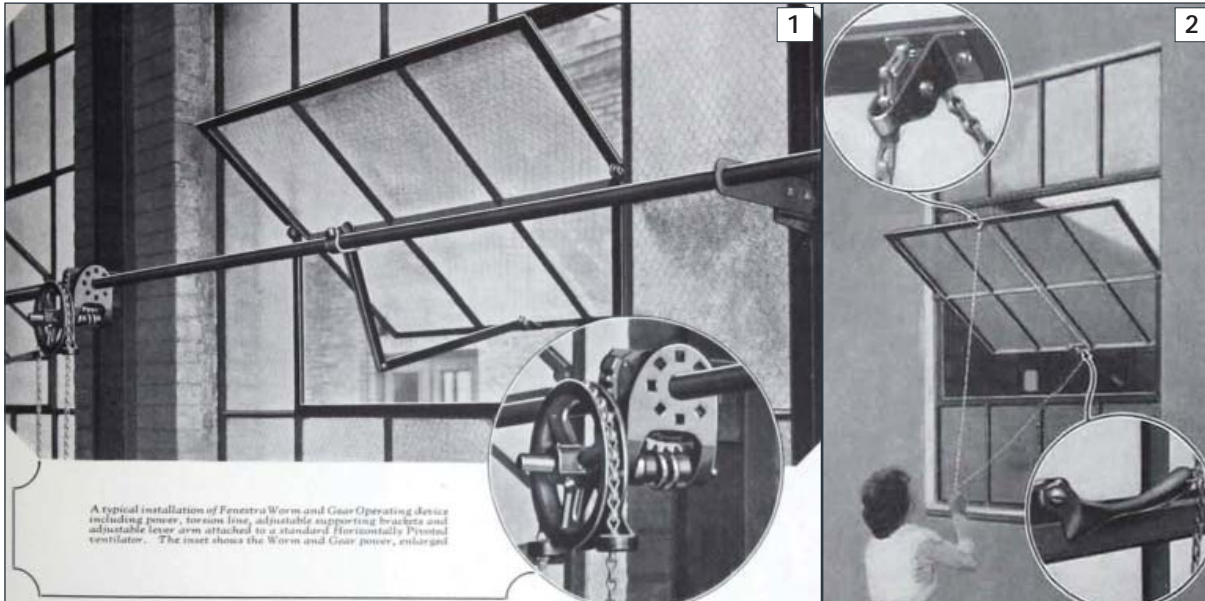

The height of steel windows called for either a mechanical (left) or manual (right) method of operating movable panels for ventilation. Continued use is key for keeping operability as designed.

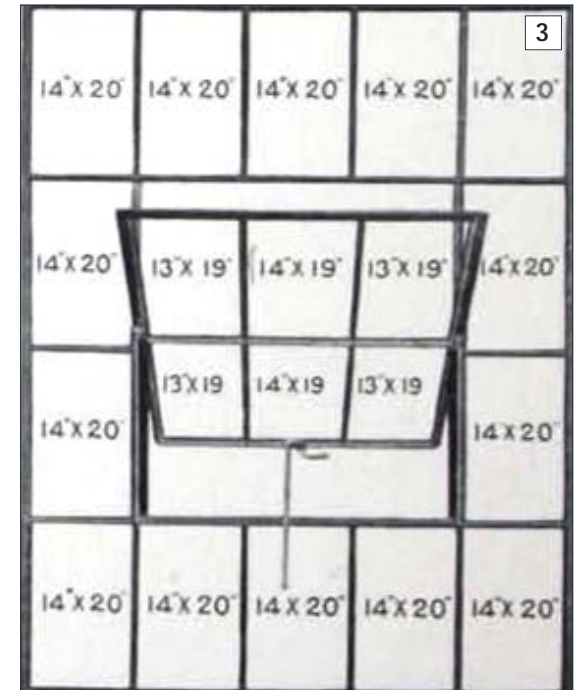

A central operable panel is a common configuration of a steel window. When replacing panes of glass, it is important to note the reduced sizes within the operable sections.

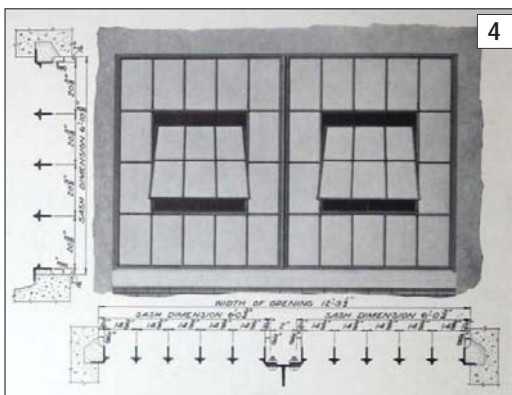

The section shows the shape and location of muntins and frames in common steel installation.



The Fenestra joint wove intersecting muntins, which produced strength and allowed for slimmer glazing bars.

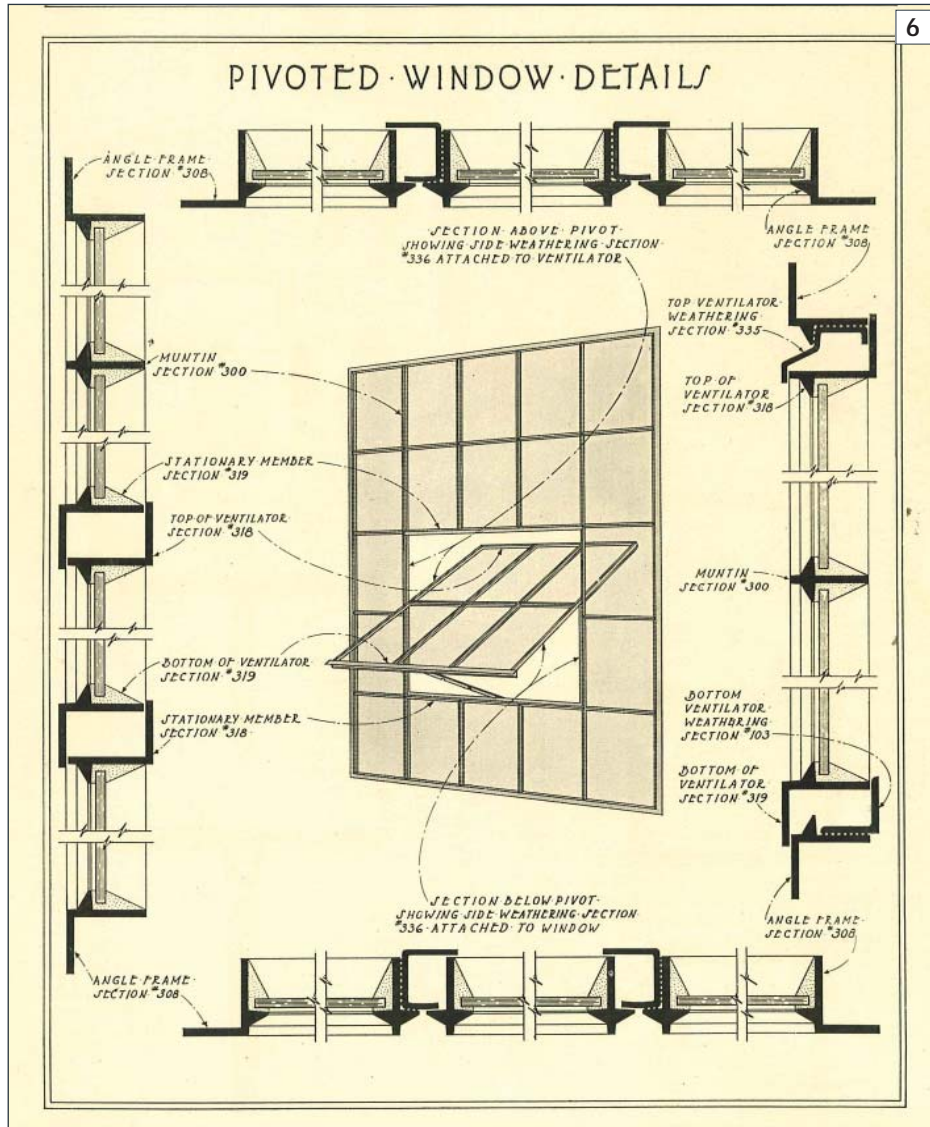

This 1927 technical diagram of a Lupton Steel Window illustrates how the window is attached to the frame.

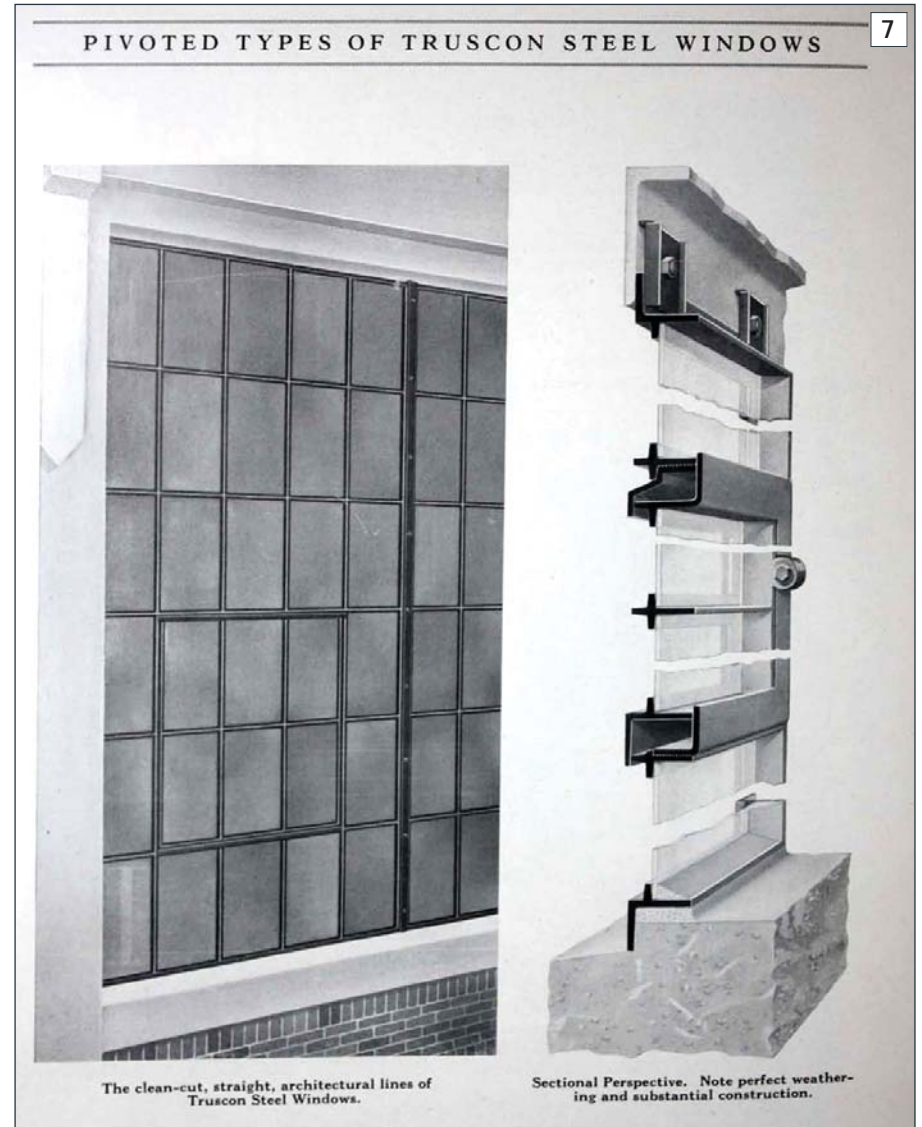

The clean-cut, straight, architectural lines of Truscon Steel Windows.

Sectional Perspective. Note perfect weathering and substantial construction.

This rendering shows the clean lines and large amounts of glass characteristic of a steel window. The accompanying sectional perspective conveys the depth of the frame.

STEEL WINDOWS

Explanation of Material



Henry Hope & Sons 1904 wrought steel windows were the predecessor to the more common rolled steel windows. The steel's strength allowed the character-defining feature of narrow muntins.

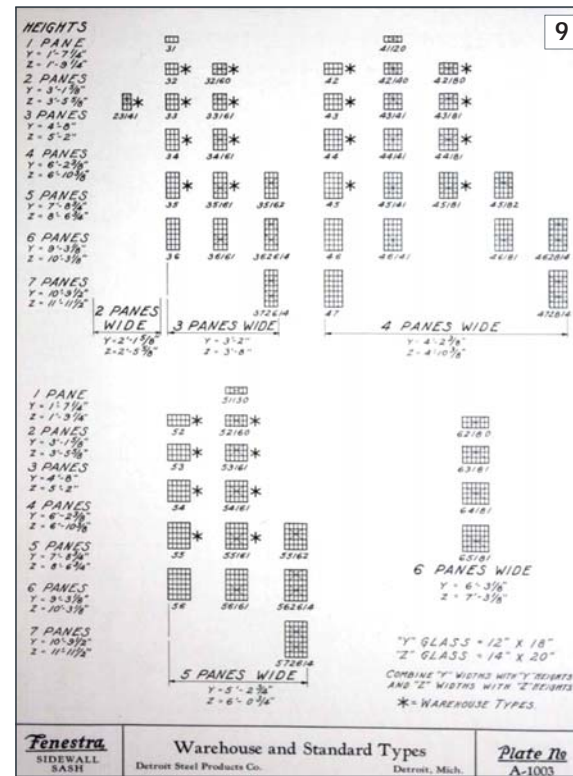

Crittall Windows Ltd. was credited for standardizing the steel window industry. Crittall opened the Detroit Steel Product Company in 1907, and this diagram shows the standard sizes of steel windows available in 1926.

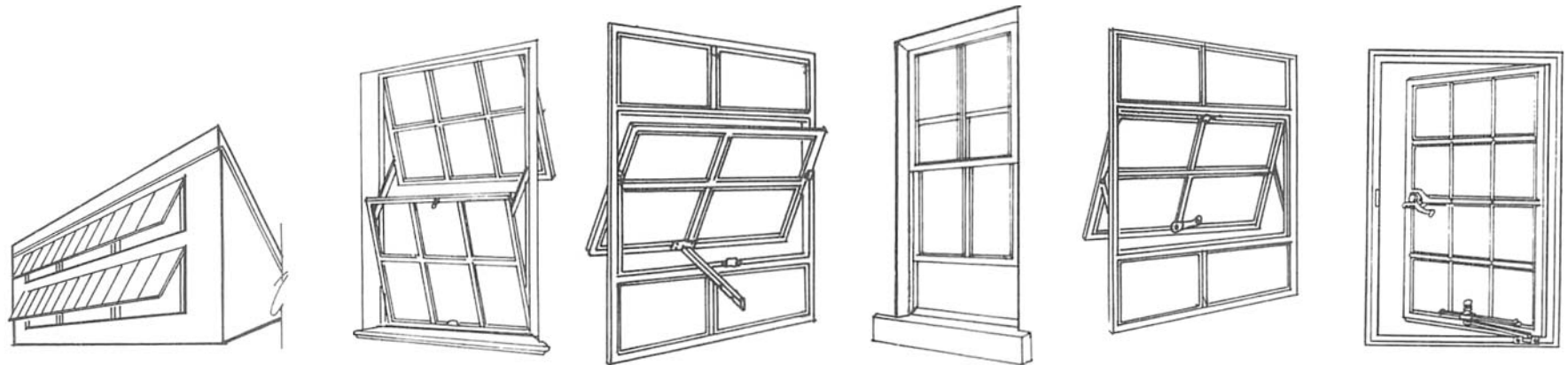

Steel windows were historically offered in various operability configurations, including (left to right) continuous, austral, pivot, double-hung, projecting, and casement.

Explanation of Construction

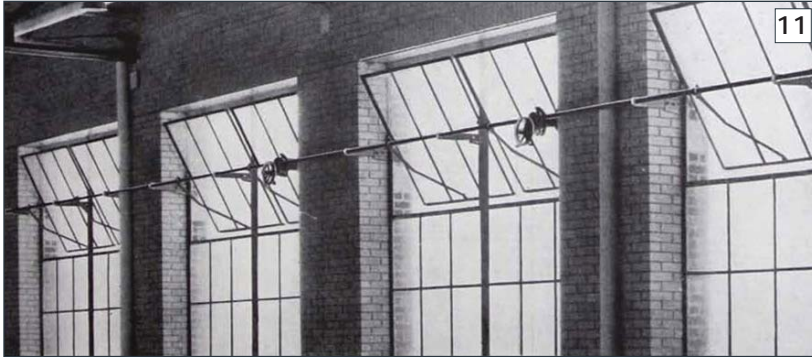

11

Tall steel windows of industrial structures often had an upper operable panel for ventilation. When in a series, all the steel windows could be connected by a mechanical operator to open and close efficiently.

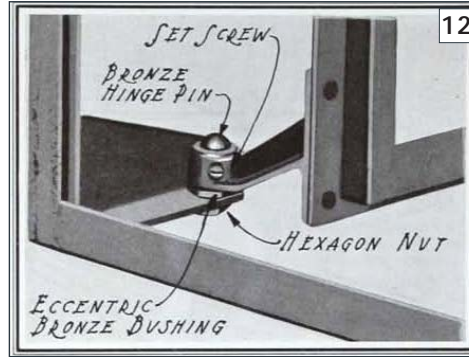

12

To further prevent rust, steel windows commonly had pins in bronze or an equally corrosion-resistant metal.

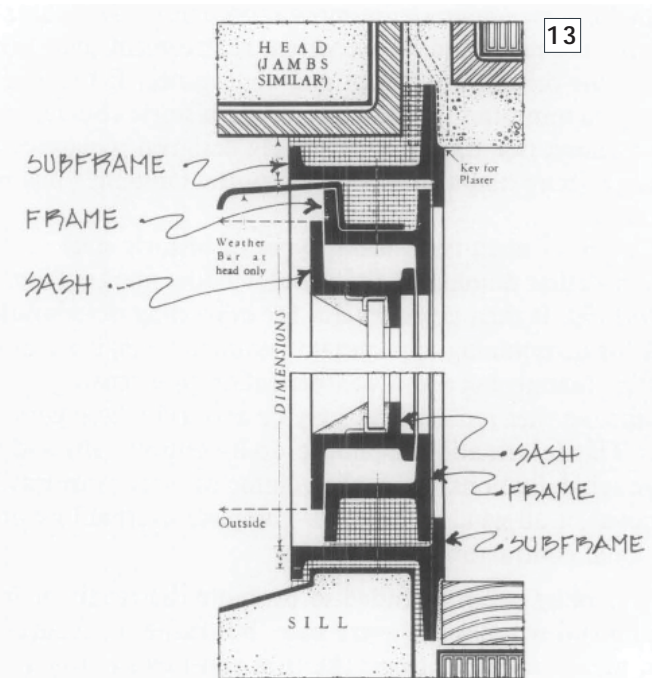

13

This section diagram shows the window assembly of subframe, frame, and sash.



14

Steel windows could be hinged at the top to create continuous windows to maximize ventilation.

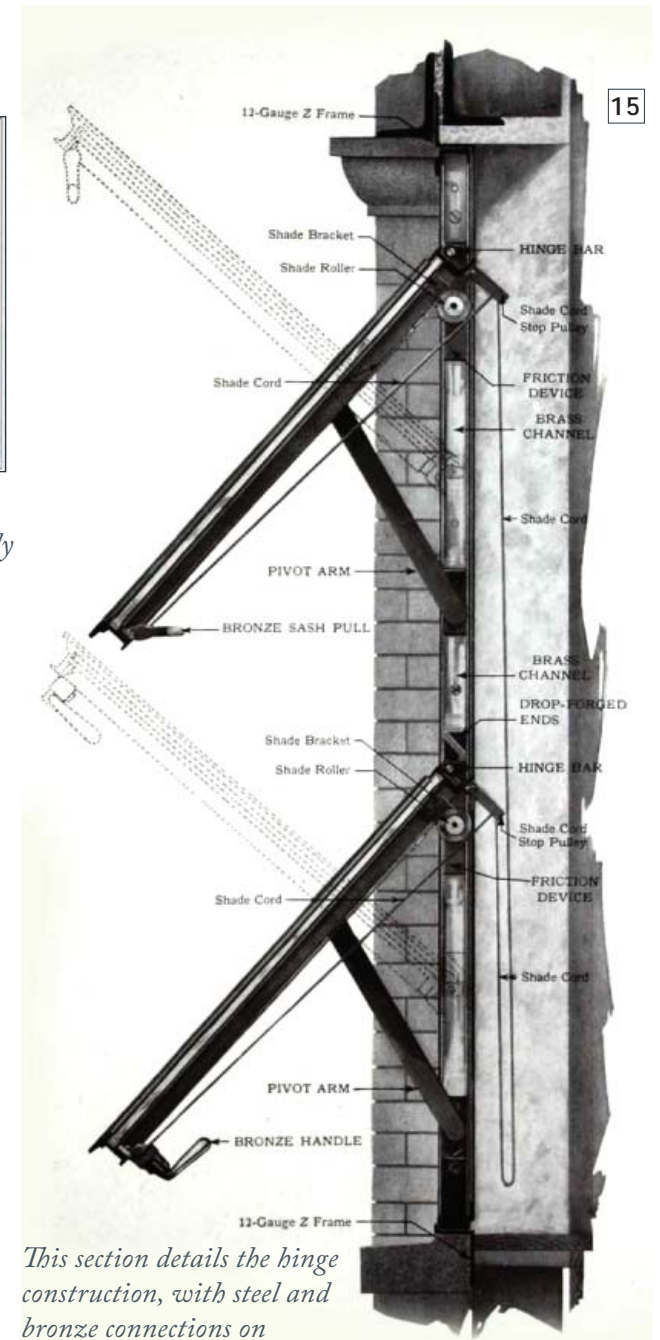

15

This section details the hinge construction, with steel and bronze connections on each sash.

STEEL WINDOWS

Examples of Common Use



Large steel windows in a series created a distinct change in the architecture of industrial and commercial structures.



Steel windows could be configured for maximum ventilation, a desirable quality for utilitarian structures like power houses and boiler rooms.



The strength of steel allowed for large expanses of glass that allowed maximum light. This was seen as beneficial in institutional buildings like schools, laboratories, and research facilities.



Steel windows could also be scaled back in size for use in residential buildings.

STEEL WINDOWS

Examples of Common Use



A continuous steel window after rehabilitation at Portsmouth Naval Shipyard, Building 240. (Photographer: Kerry Vautrot, 2014)



This steel window shows signs of corrosion, a common occurrence in industrial applications. Located at NSF Indian Head, Building 292. (Photographer: Thomas Wright, 2014)

25



Steel windows can be maintained with minimal actions. The steel window of Building 768 at NSF Indian Head is showing signs of corrosion, but with some scraping and repainting, the issue can be reversed. (Photographer: Thomas Wright, 2014)

26



The popularity of steel windows was apparent in work spaces of all types and configurations.

STEEL WINDOWS

Examples of Common Use

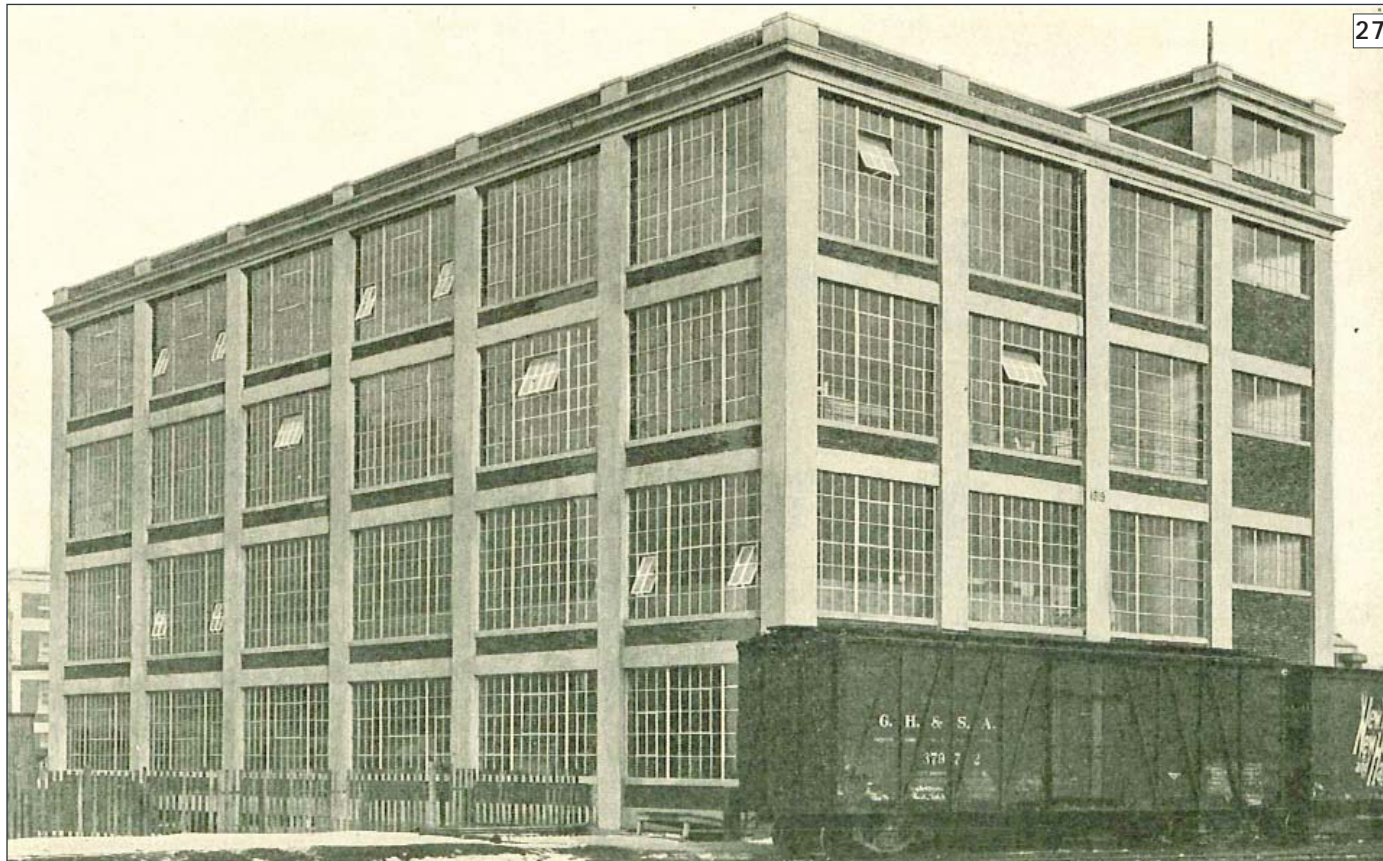

The benefits of light, ventilation, and easy maintenance resulted in large expanses of steel windows in industrial buildings.

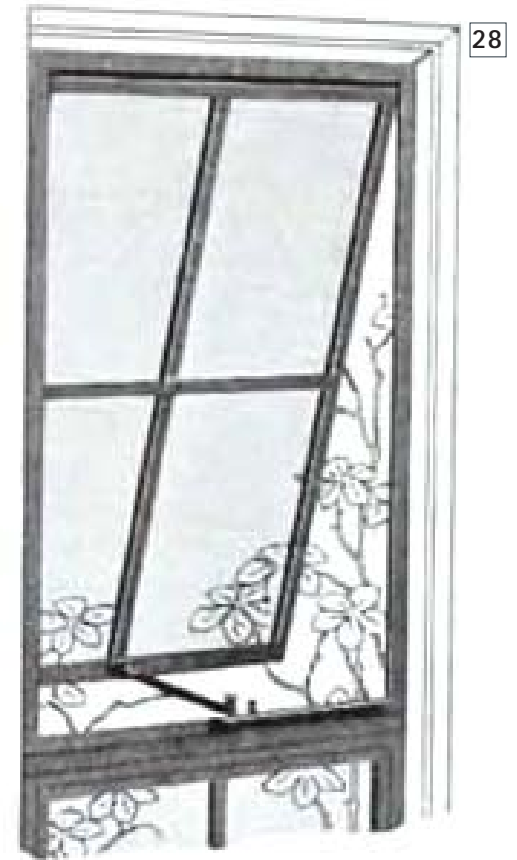

The same benefits were recognized and used in traditional window sizes for residential construction.

Replacements

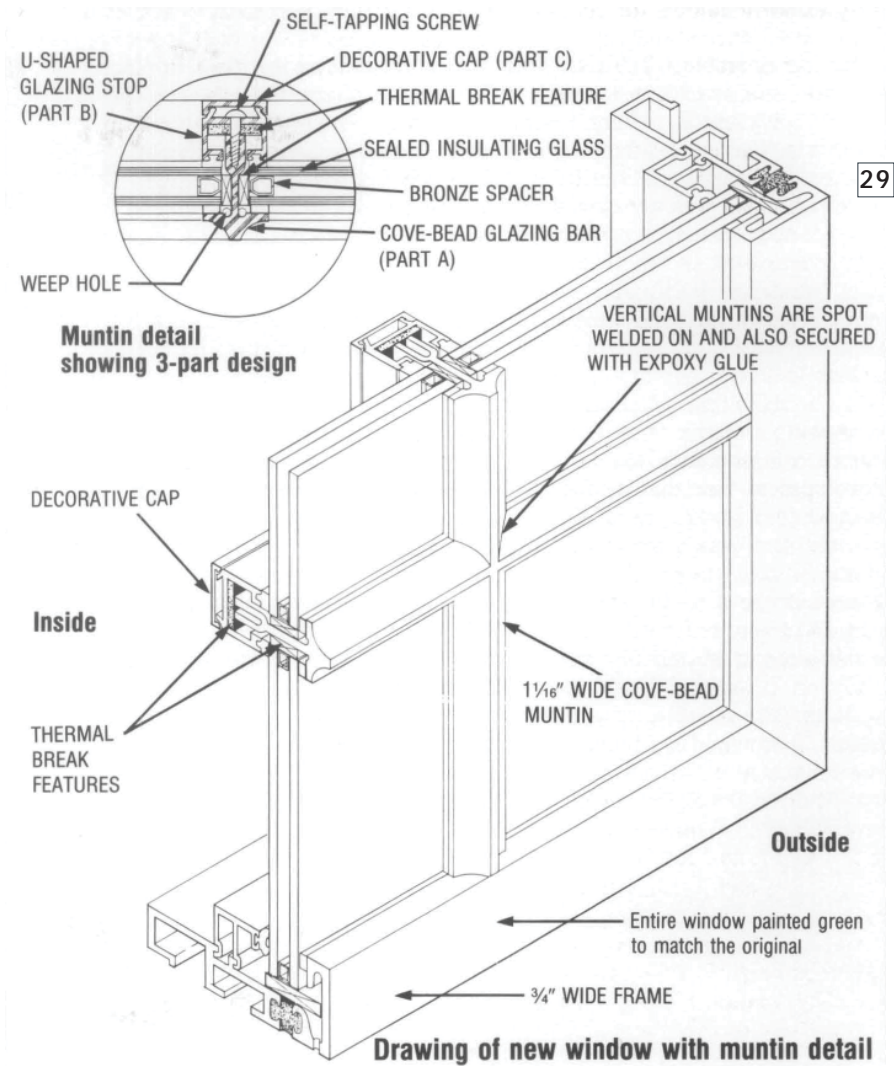

Today, steel windows are often replaced with aluminum. This diagram shows how an aluminum replacement attempts the configuration of steel windows, while adding additional thermal insulation.

❖ CORRUGATED WIRE GLASS

Explanation of Material

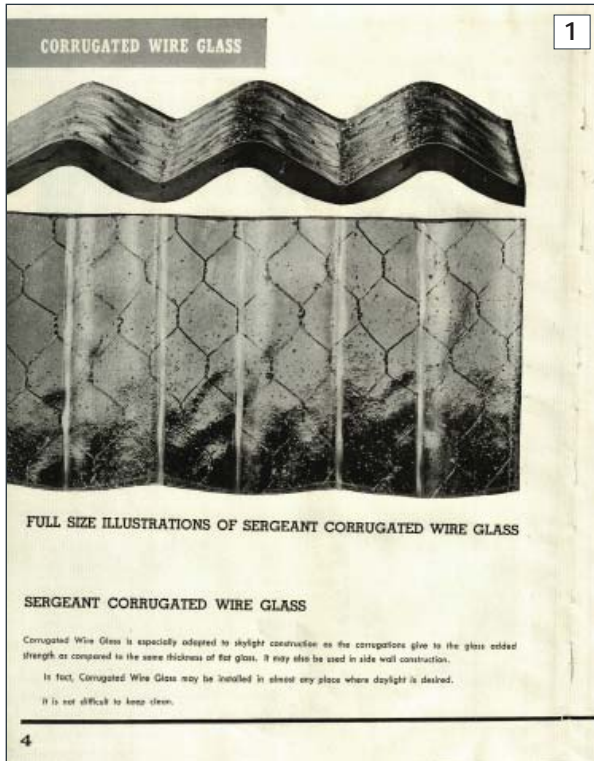

Corrugated wire glass is described as glass with a wire mesh enclosed within the surfaces of the sheet, then corrugated, which creates a continuous curve.

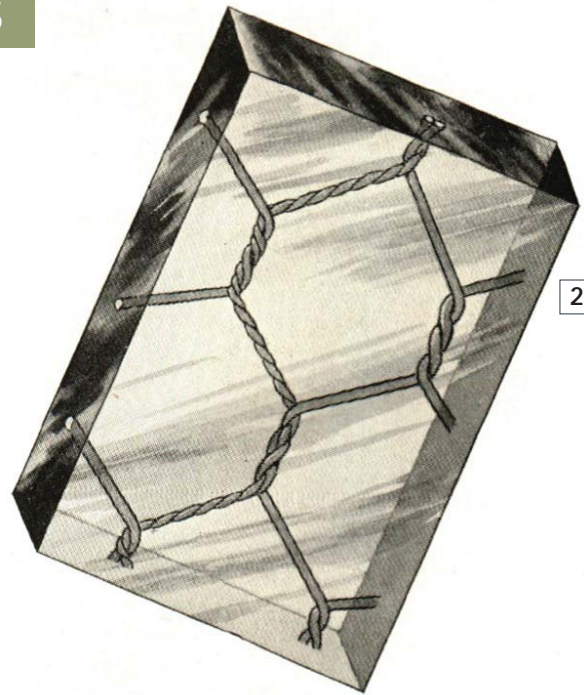

Wire glass, invented in 1892, is stronger than plain glass and the wire mesh is able to hold the glass shard in place when broken.



Actinic glass was an amber-tinted glass that excluded 85% of ultra-violet rays and further contributed to glare protection.

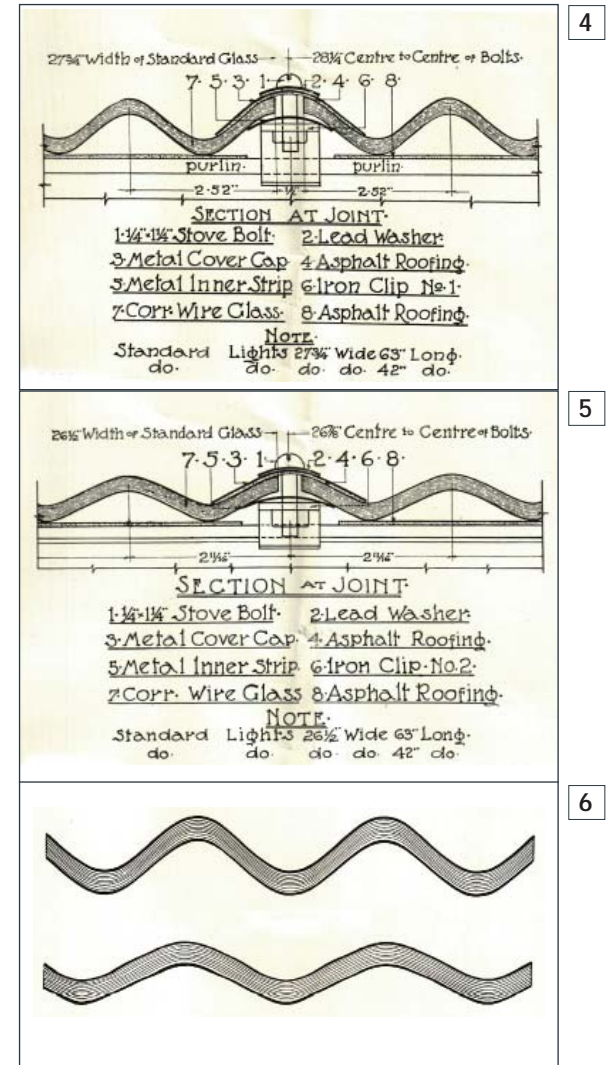

Corrugated wire glass came in two types: deep or shallow corrugation, shown here in cross section. Deep corrugation has a steeper angle with 2 1/2" from corrugation to corrugation. Shallow corrugation has a more gradual angle with 2 11/16" from corrugation to corrugation.



The Hires Turner Glass Company called corrugated wire glass “the lightest and strongest building material of its character obtainable,” and promoted it as the answer to many issues of existing industrial construction. The large panels allowed large expanses of glass without obstruction (left), and the corrugations allowed a much greater load than regular flat glass (right).

❖ CORRUGATED WIRE GLASS

Explanation of Construction

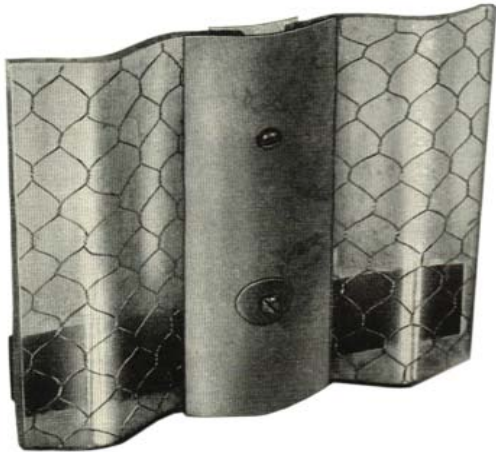

9

Corrugated wire glass panels were joined by a metal cover cap, shown here. When properly installed, the construction system was waterproof.



10

Panels were generally installed directly on the superstructure and could be adapted to and installed on steel, wood purlins, or concrete.



11

NEW YORK and Pennsylvania Company, Johnsonburg, Pa. This concern has replaced a very great number of their old skylights with C. W. G. and write us that it stays clean and that they have no breakage.

Three men are all that are required to properly install C. W. G.

Over a period of years the New York and Pennsylvania Company have used many thousands of sq. ft. of C. W. G.

The panels were as lightweight as any building material on the market, and eliminated the need for specially constructed skylights or windows. The materials could be easily and quickly erected by only a few men, as shown here.

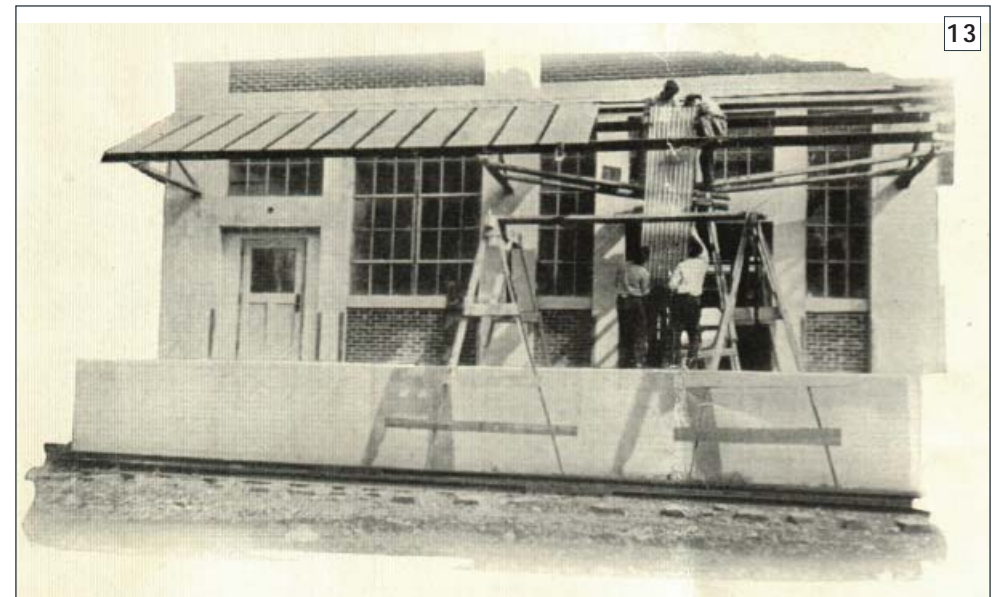
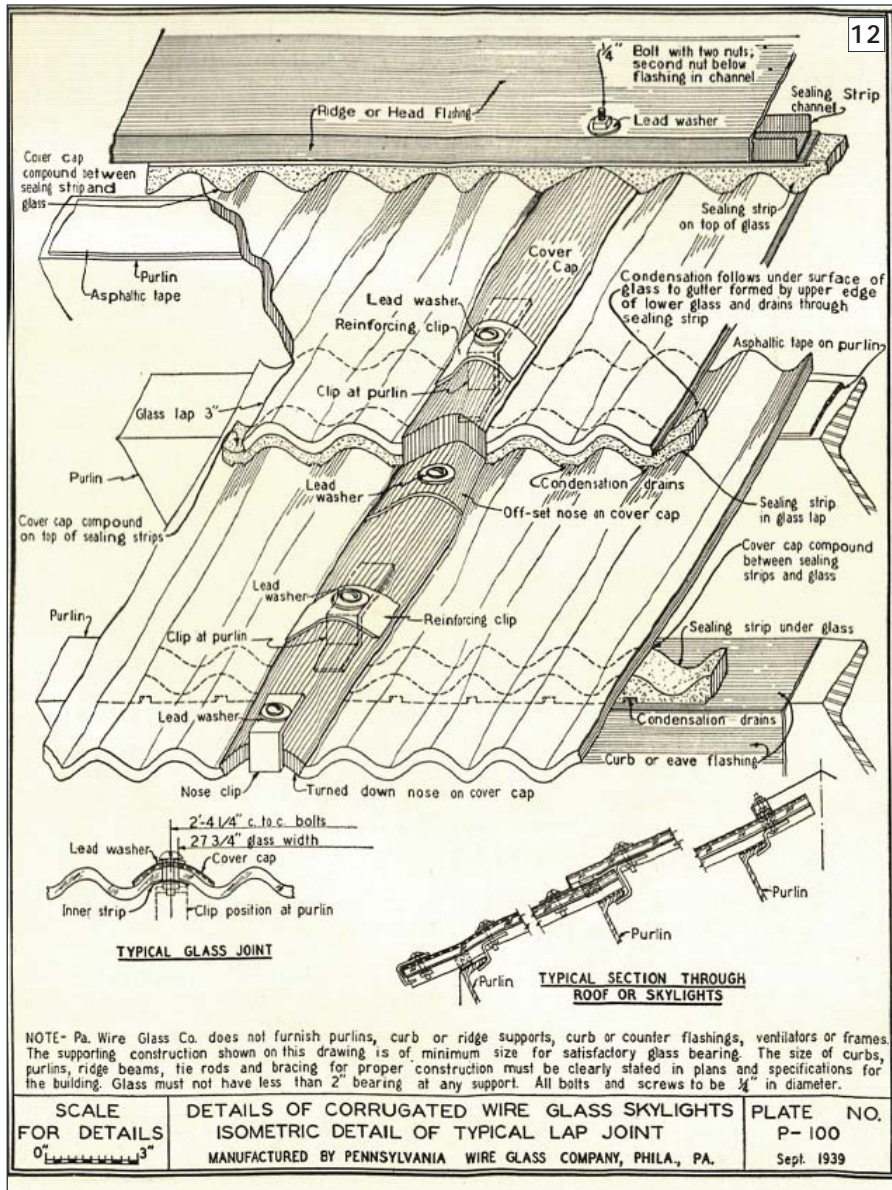

The panels were also commonly used for canopies, shown here with another three-man team completing the construction.

This three-dimensional diagram shows the overlay construction of corrugated wire glass skylights, including how the corrugations mesh to create a waterproof connection.

❖ CORRUGATED WIRE GLASS

Examples of Common Use



14



15

Combining the key characteristics of immense strength, diffused light, flexibility, fire resistance, and simple maintenance, corrugated wire glass found early popularity as an ideal material for skylight construction.



16

The diffused light allowed for bright interiors without shadows, an important quality when dealing with machinery and factory work.

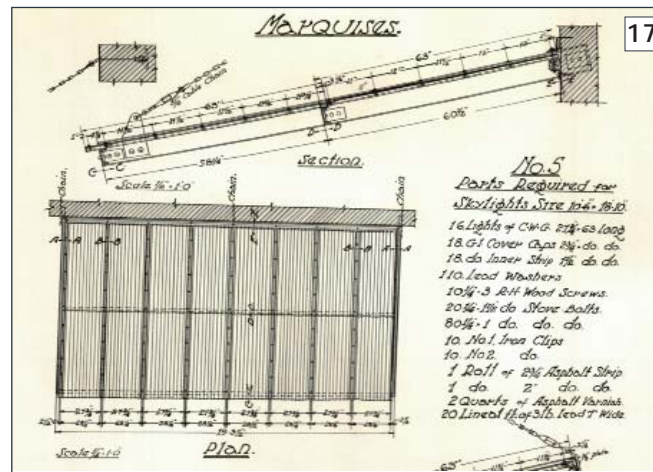

17



18

Corrugated wire glass was also used in marqueses, as shown here in drawing (left) and application (right).

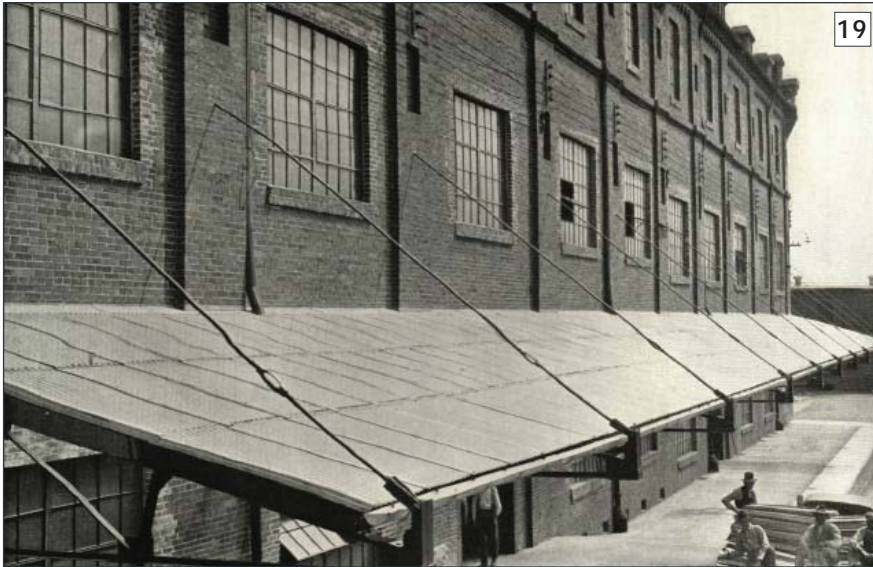

Corrugated wire glass allowed light with protection and became a common detail of industrial structures.



The panels could be a maximum 60" clear span without intermediate support, lending them to be a popular choice for side wall construction.

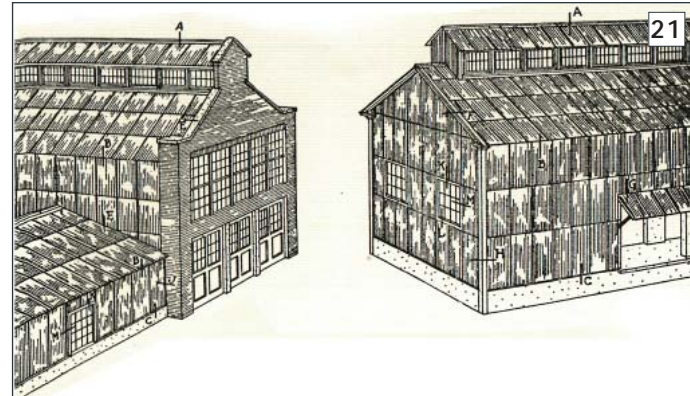

The lightweight yet strong material was soon advertised for every surface of an industrial structure.



Two examples of the use of corrugated wire glass at the Philadelphia Navy Yard, in the Pipe and Copper Shop (top) and Structural Assembly Shop (bottom).

❖ CORRUGATED WIRE GLASS

Examples of Common Use



Corrugated wire glass could be used on small-scale projects as well, shown here as a skylight replacement material.

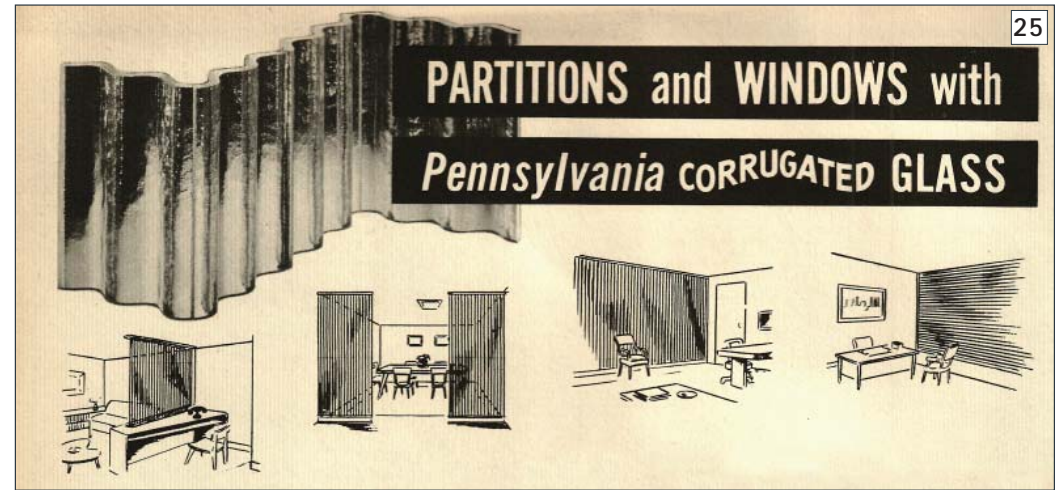

Corrugated wire glass was adapted to residential application by the 1950s as just corrugated glass; the wire mesh was removed.

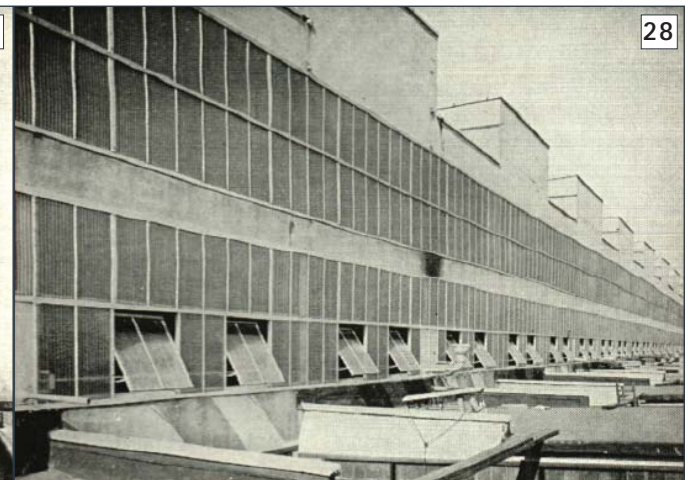
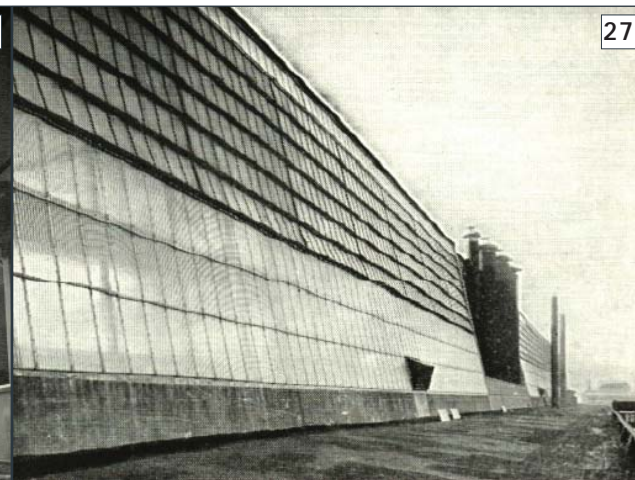

Corrugated wire glass was more commonly used in large expanses. It is shown here in various applications with the goal of maximum, diffused light.

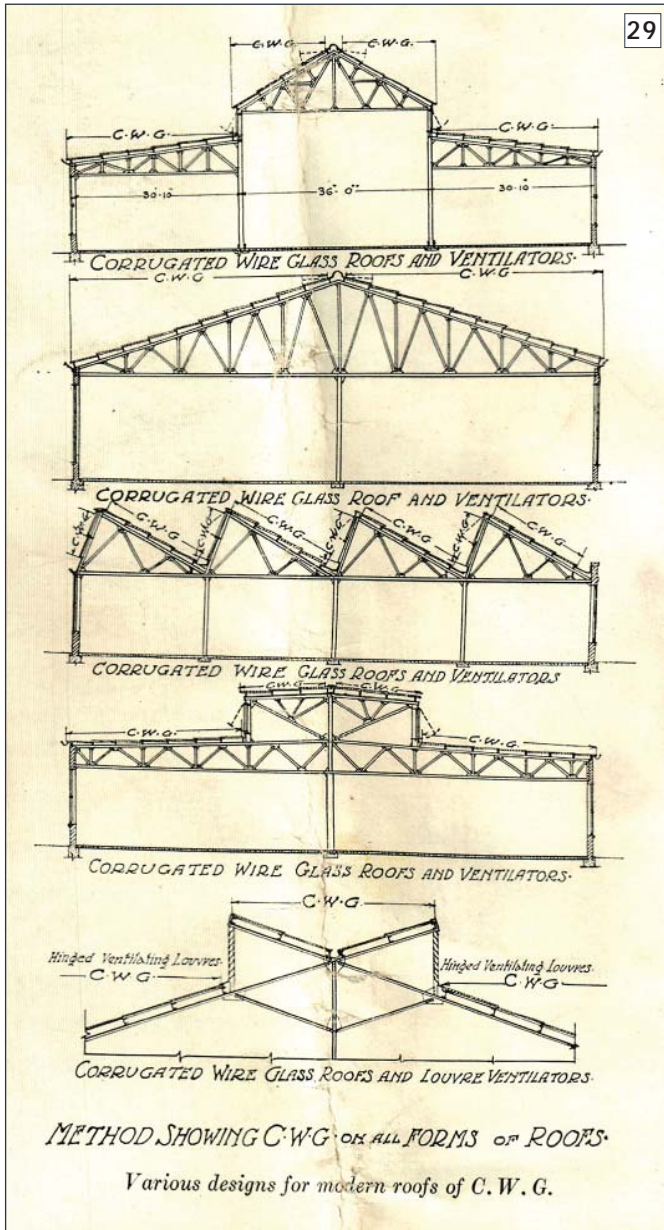

The use of corrugated wire glass was adapted to various roof types.

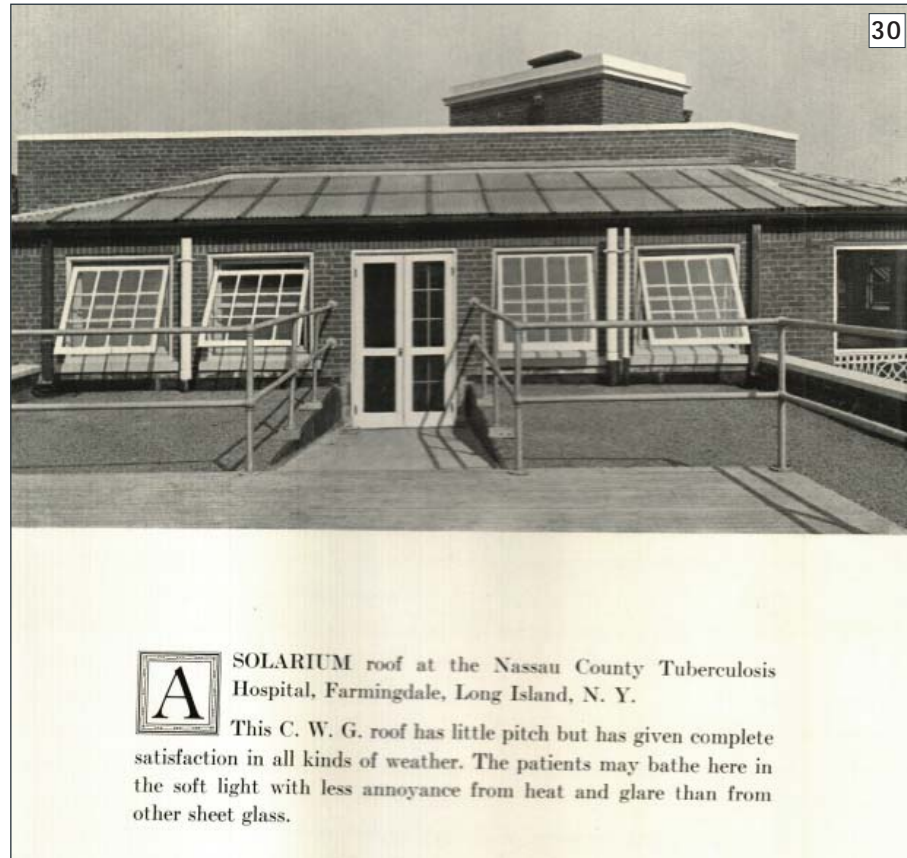

Institutional buildings soon recognized the usefulness of diffused light, such as in this hospital application.



Corrugated wire glass was a dominant building material in the American industrial landscape.

❖ CORRUGATED WIRE GLASS

Examples of Common Use



The corrugated wire glass of Portsmouth Naval Shipyard Building 159 is an example of use on a smaller scale. (Photographer: Kerry Vautrot, 2014)



The most common application of corrugated wire glass was in large expanses, shown here in the curtain wall of Portsmouth Naval Shipyard Building 92. (Photographer: Kerry Vautrot, 2014)



The corrugated wire glass window of Portsmouth Naval Shipyard Building 153 shows the qualities of diffused light and privacy. (Photographer: Kerry Vautrot, 2014)

GLASS BLOCK

Explanation of Material

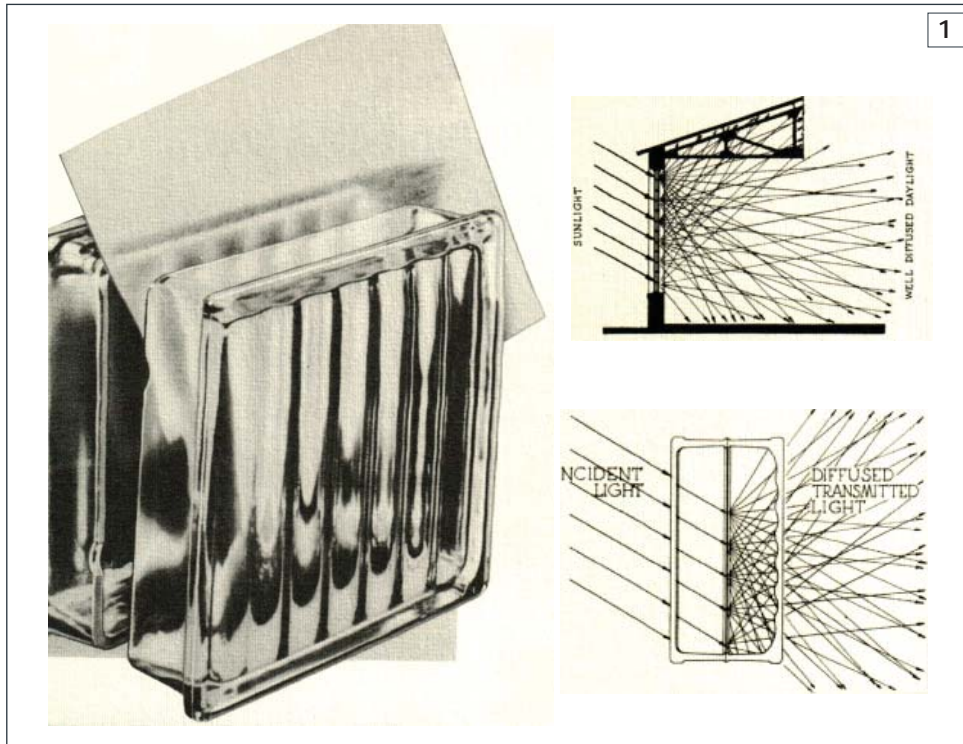

Glass block became popular as a window material because of its ability to create diffused and directional daylighting without increasing heat, causing glare, or sacrificing privacy.

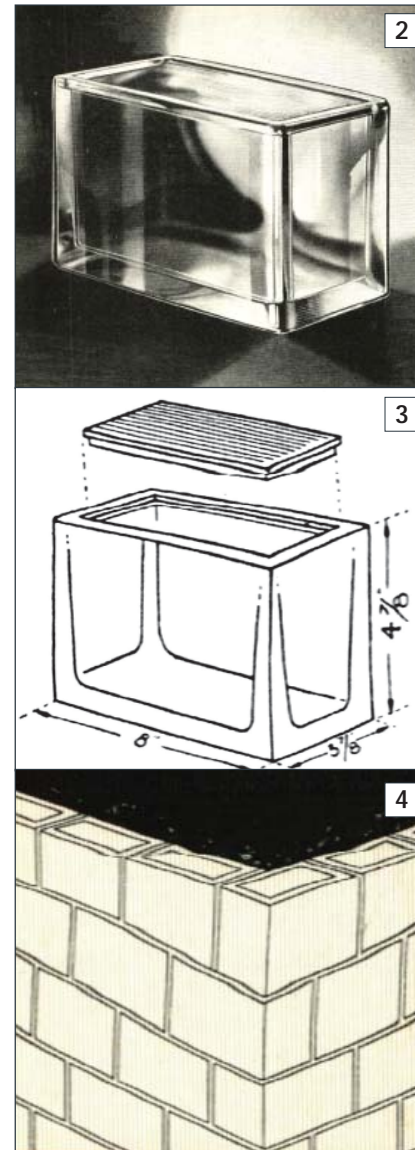

Owens-Illinois Glass Company's first glass block design was a hollow, six-sided unit made by separately pressing a five-sided unit and a lid. The lid was then hermetically sealed and had the dimensions of a masonry brick.

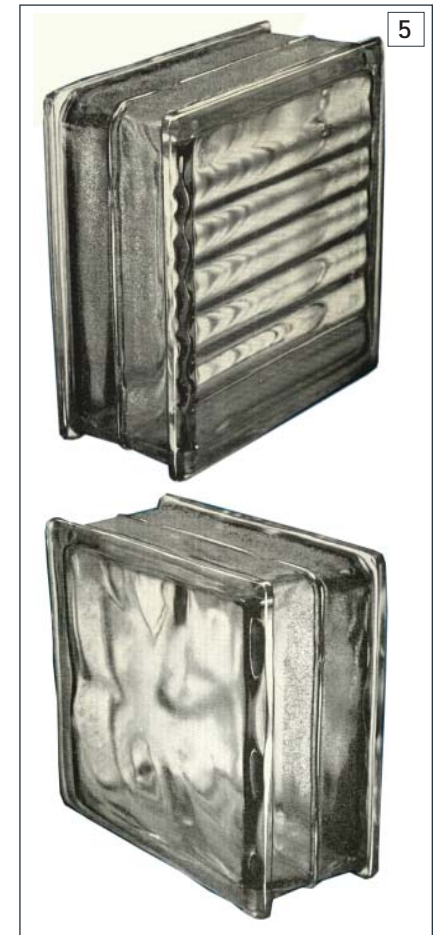

Glass block was developed in various patterns and designs to adapt to a range of lighting issues, including designs to control the direction, diffusion, and distribution of light.

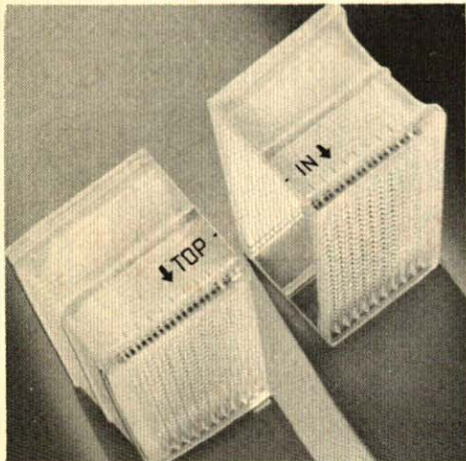

← Typical of the **DIRECTIONAL** type is the PC Soft-Lite Prism B. Internal prisms direct incident daylight to the reflecting ceiling—as shown in the accompanying diagram—whence it is distributed to seeing task areas.

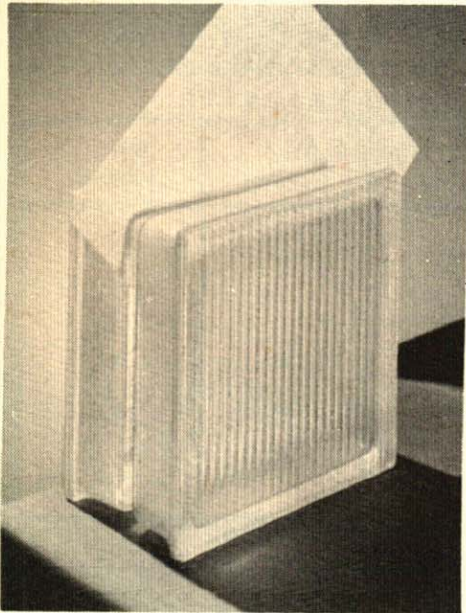
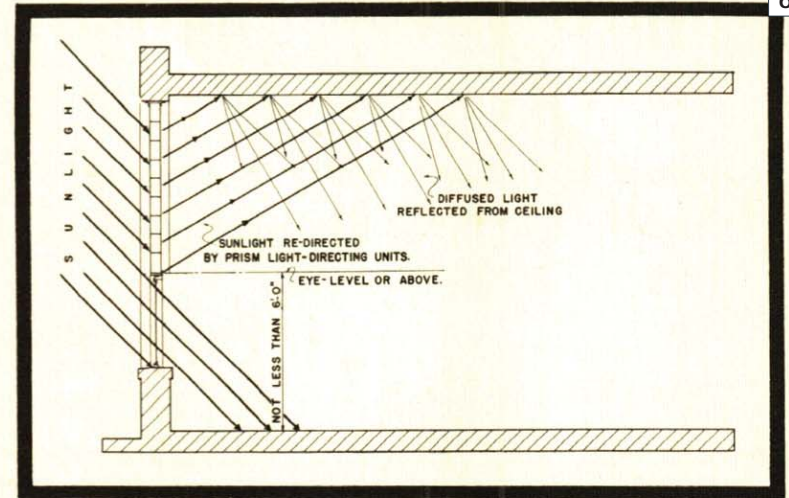



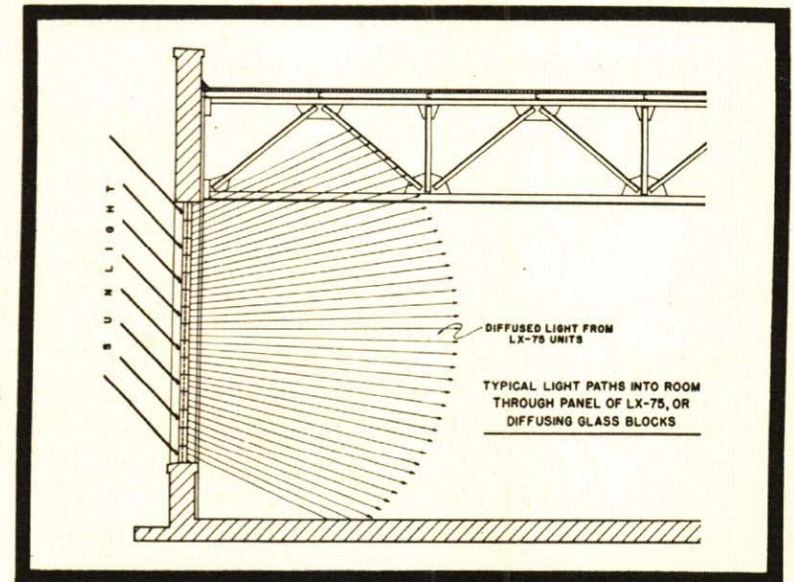





← Typical of the **DIFFUSING** type is the PC Bristol LX-75. A sheet of fibrous glass is inserted and permanently sealed between the two halves of the block during its manufacture. This screen—creating a double cavity—effectively diffuses light as the accompanying diagram shows.



Pittsburgh-Corning Corporation used this diagram in 1949 to explain the two types of glass block they offered: one which controlled where the light was projected, and another using a fibrous glass screen to eliminate direct light.

GLASS BLOCK

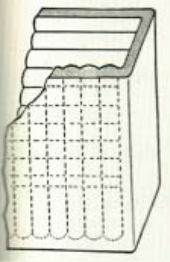
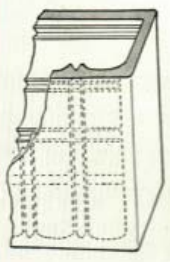
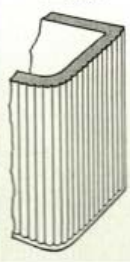
Explanation of Material

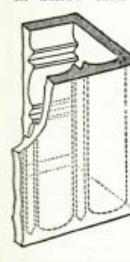
DESIGN NO. 16	DESIGN NO. 17	BULLNOSE	QUARTER ROUND	LIGHT TRANSMITTING CORNER	RADIAL
					
TRANSMITS 84.4% OF INCIDENT LIGHT	TRANSMITS 84% OF INCIDENT LIGHT	Non-light-transmitting corner block to be used with No. 100 series. Size 3 7/8 x 3 7/8 x 4 7/8 in. Vertical exterior ribs on faces adjacent to bullnose corner, 1/4 in. ribs on the "A" block and 1/2 in. ribs on the "B" block.	Non-light-transmitting corner block to be used with No. 200 and 300 series. Size for 200 series 3 7/8 x 3 7/8 x 5 1/4 in. and for 300 series 3 7/8 x 3 7/8 x 7 1/4 in. Vertical exterior ribs, 1/4 in. and 1/2 in. on "A" and "B" blocks respectively.	Block to be used with No. 100, 200 and 300 series. Height 4 7/8 in. for 100 series, 5 1/4 in. for 200 series, 7 1/4 in. for 300 series. Vertical ribs on face of large radius and horizontal on face of small radius, 1/4, 1/2 and 1 in. ribs for "A," "B" and "C" block respectively.	Radial block can be laid to varying radii from 3 ft., 6 in. to 6 ft. through variation in mortar joint. Width of long face 7 3/4 in., of short face 7 in. Pattern same as No. 317 Block with inside ribs, vertical on wide face, horizontal on narrow face.
					

In 1939, the Owens-Illinois Glass Company advertised for various patterns and shapes of glass block.

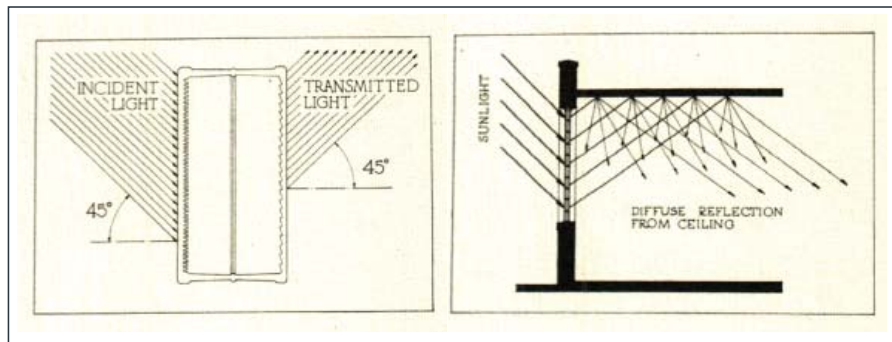

This diagram shows the angles in which light enters and leaves a directional glass block.

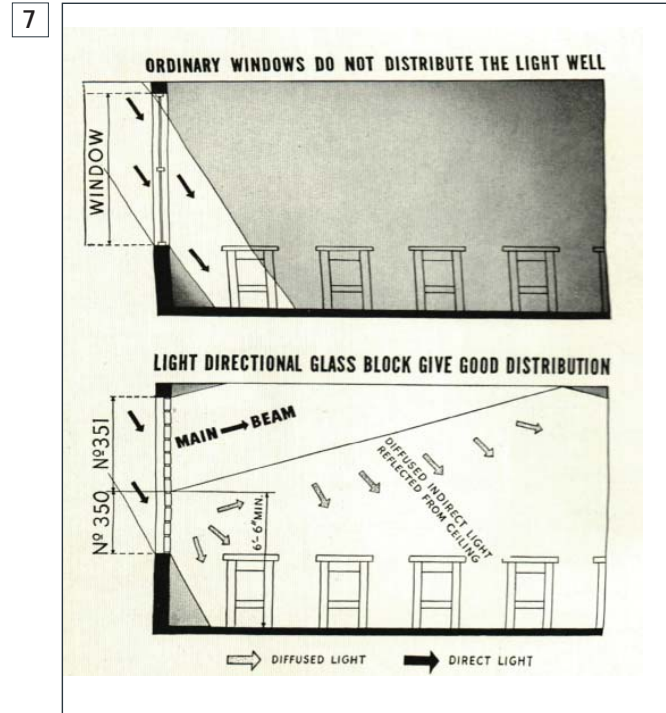

This diagram shows the benefit of directional glass block in a classroom. The top diagram shows how light is distributed in a traditional glass pane window. The bottom diagram shows how by directing the light through glass blocks, the interior is brighter and consistent.

Explanation of Construction

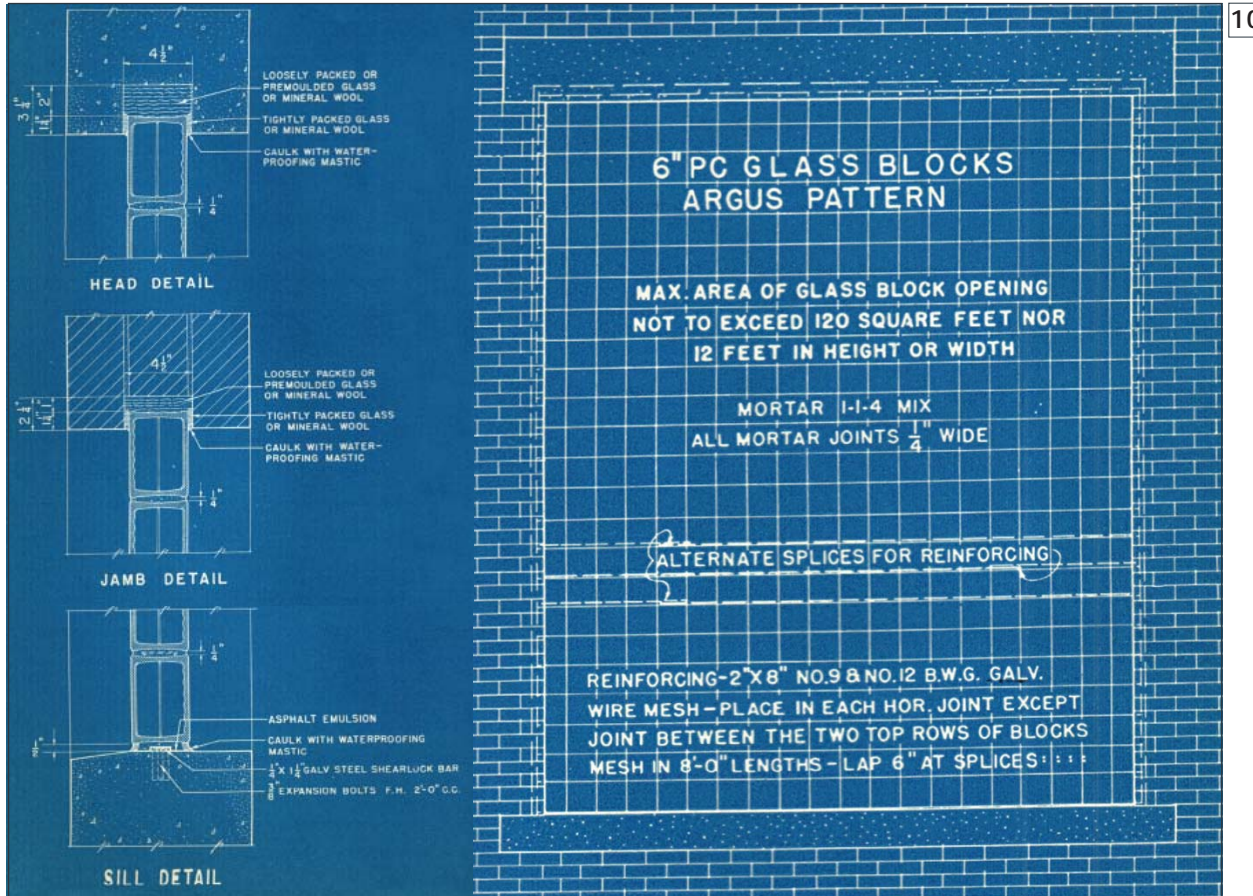

This 1939 Pittsburgh-Corning Corporation blueprint shows the recommended construction details for a fire-proof glass block panel, including head, jamb, and sill details.

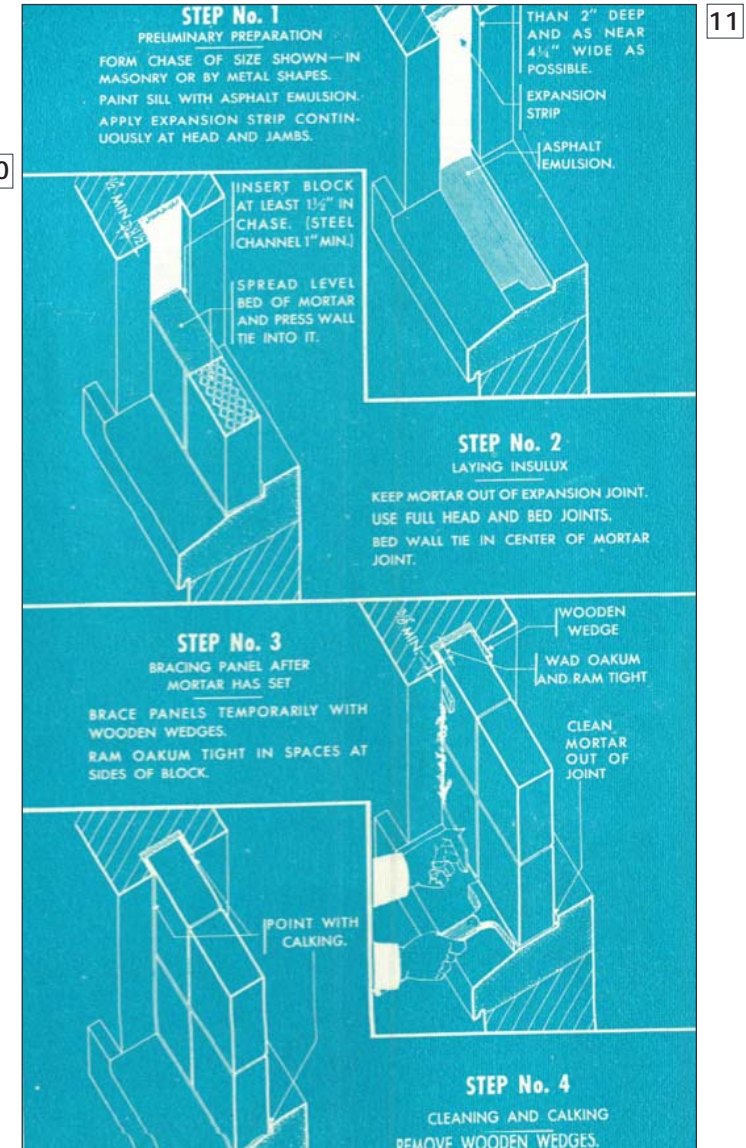

This construction diagram shows the simplicity of construction, as glass block is laid in a similar fashion to traditional masonry.

GLASS BLOCK

Explanation of Construction

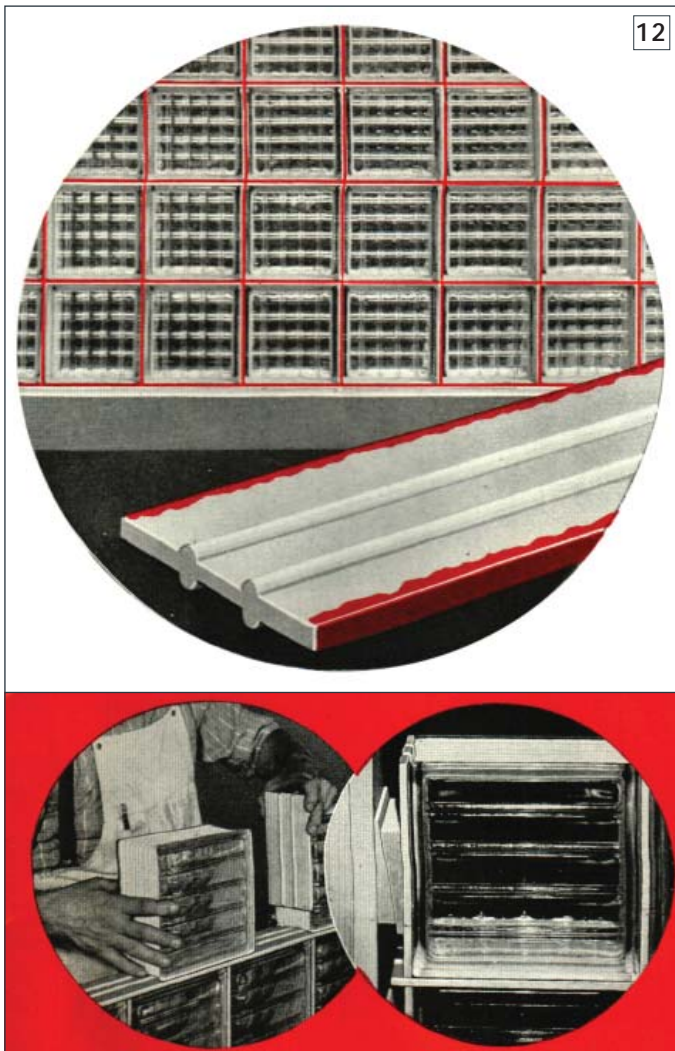

Photographs of the construction process show mortar was laid so that joints measured at least 1/4" thick.

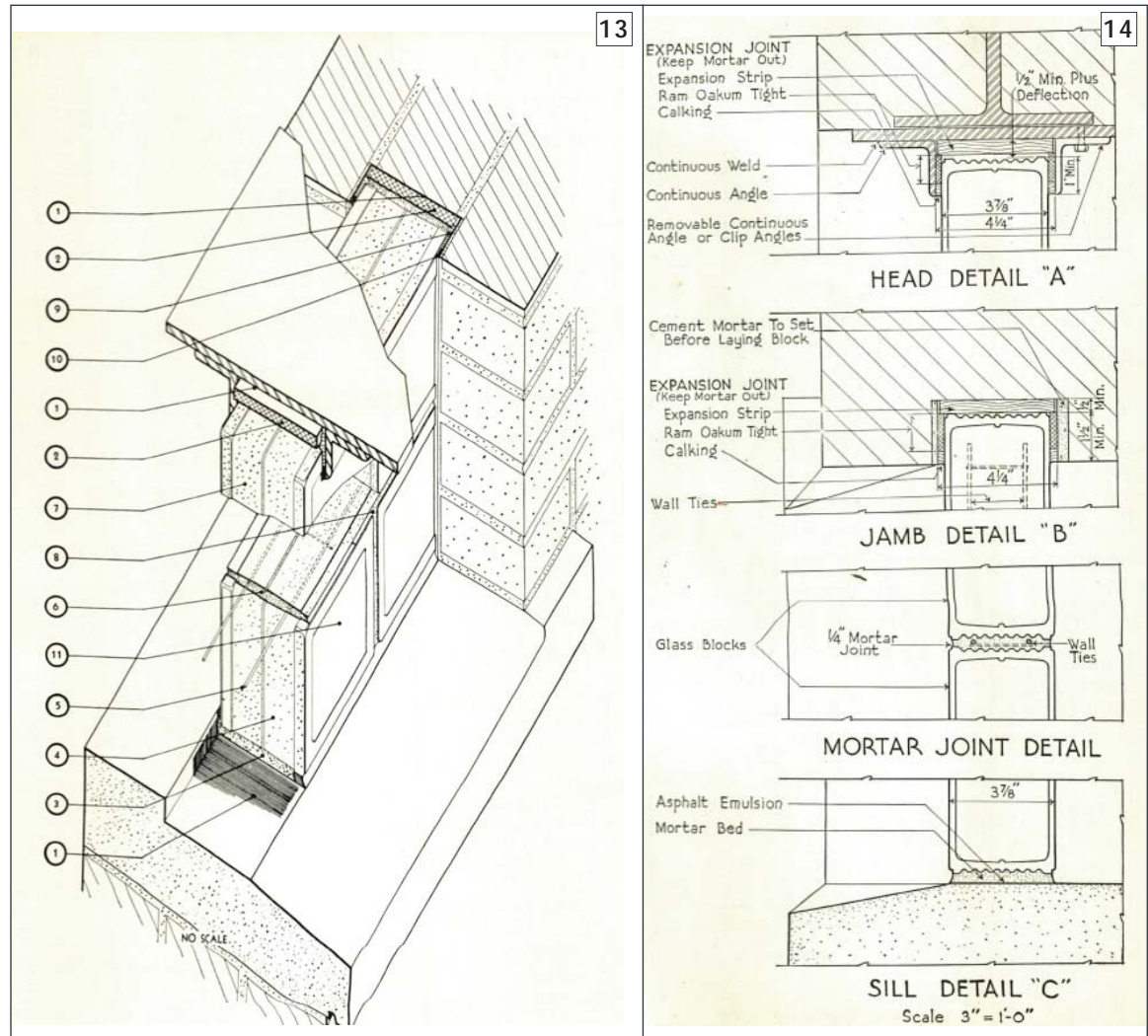

This three-dimensional section diagram shows sill and jamb construction (left) and drawing details (right).

Examples of Common Use



Commercial buildings benefitted from the increased daylight, and glass block was considered the perfect material to show window displays in a natural light.

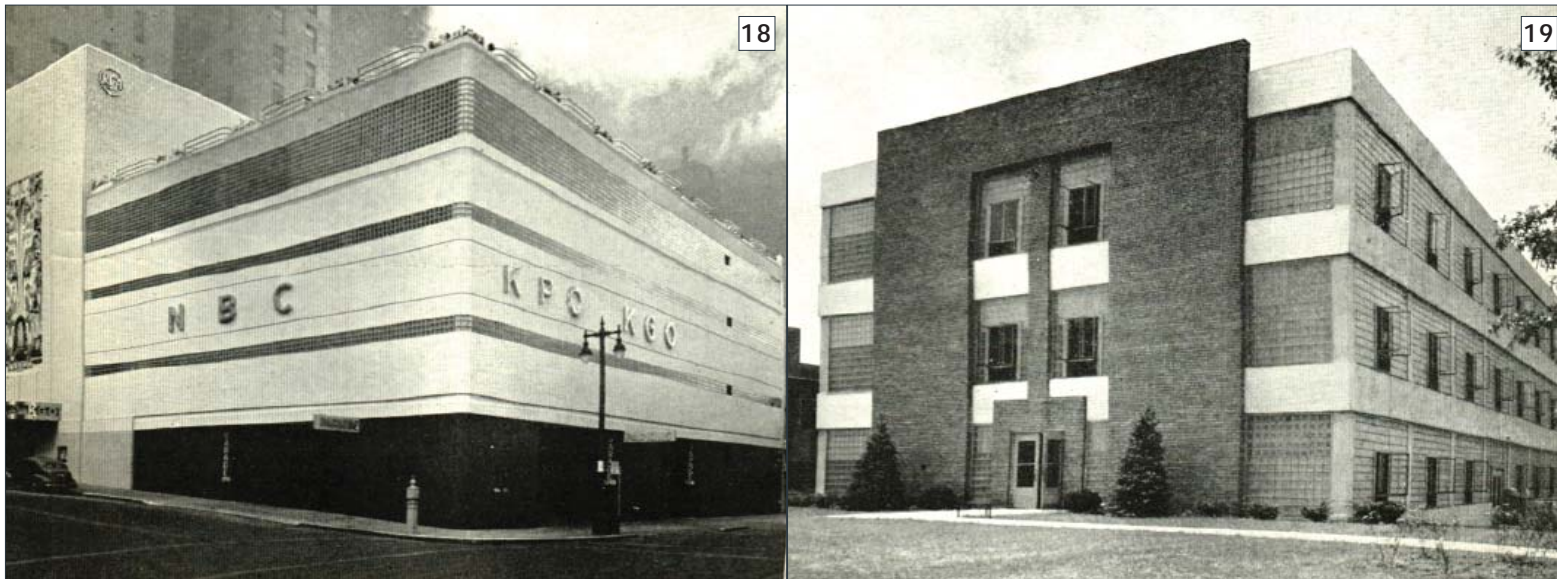

The ability to control heat loss meant a more practical material for large expanses of window walls.

GLASS BLOCK

Examples of Common Use

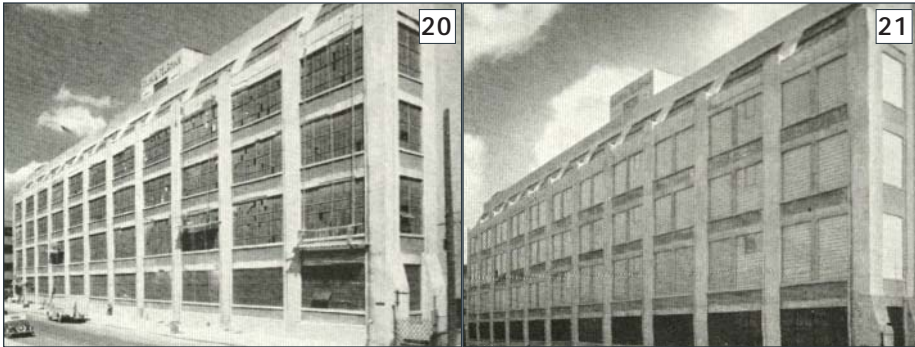

Glass block also became a popular choice for sash replacement.

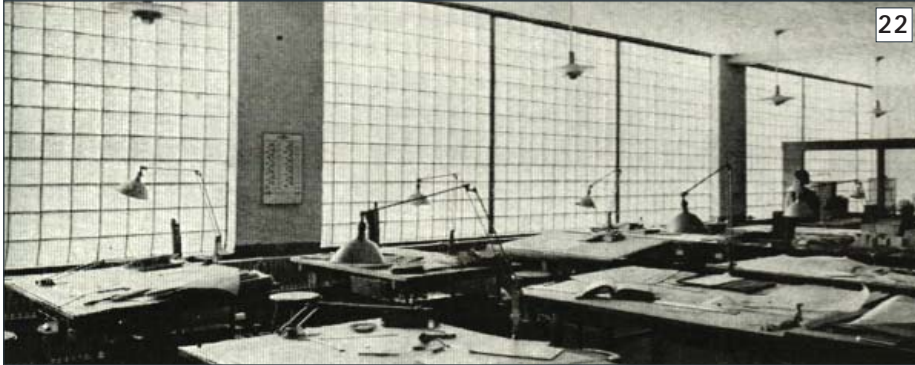

Glass block allowed diffused light and minimal shadow, considered perfect for drafting offices, as seen here.

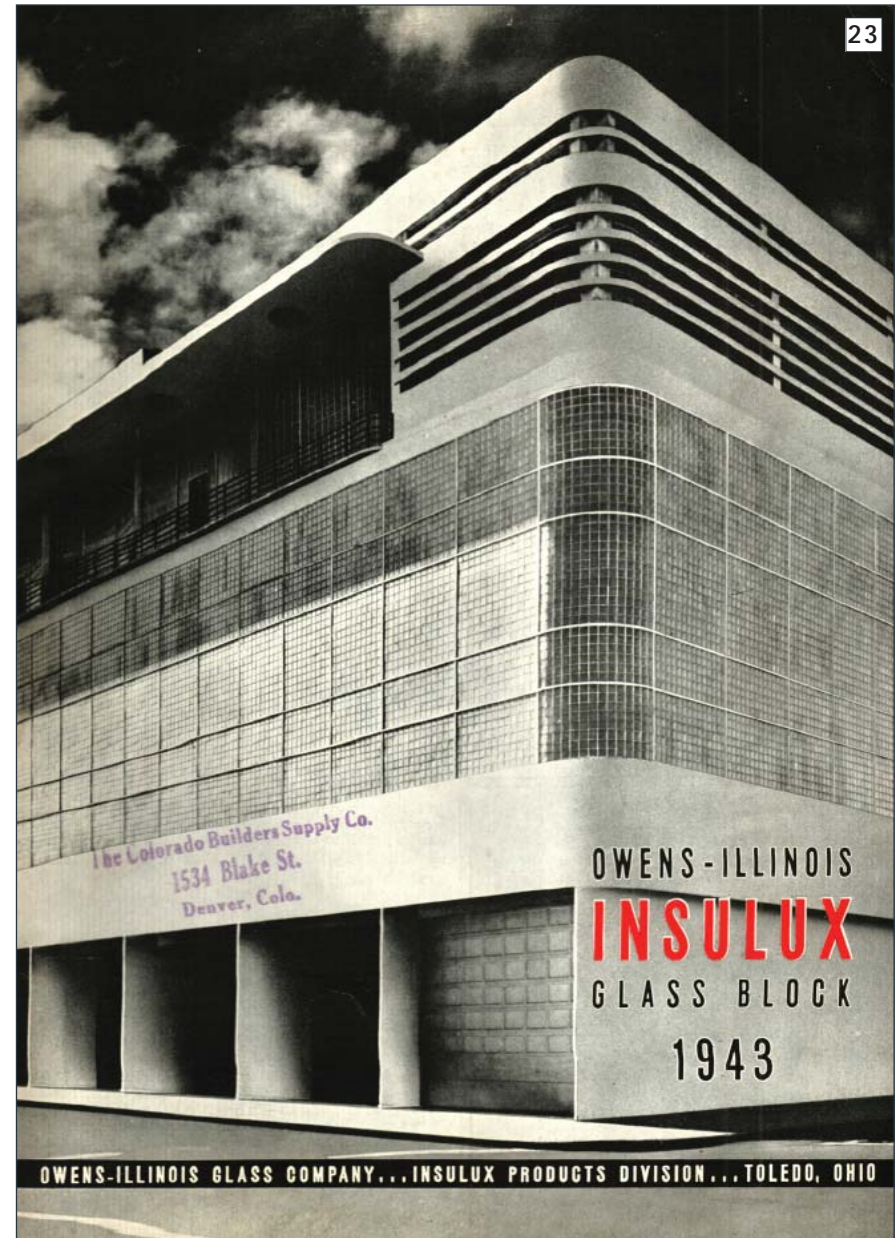

The glass block curtain wall maximized yet diffused daylight, obstructed direct views within, and maintained thermal control similar to a masonry wall.



The privacy of glass block walls made it popular for exterior and interior walls of offices, where light was needed but sound was insulated.

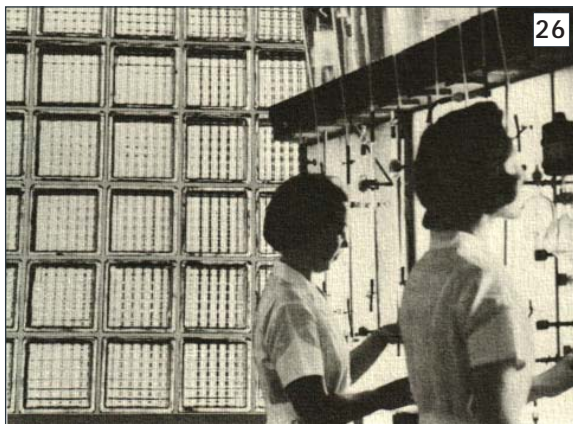

Laboratories and research facilities found glass block optimal for light without glare, sound insulation, and privacy.



Glass block was also adopted in public and institutional buildings.

GLASS BLOCK

Examples of Common Use



The residential application was especially popular, as it was seen as futuristic while remaining reminiscent of traditional masonry.

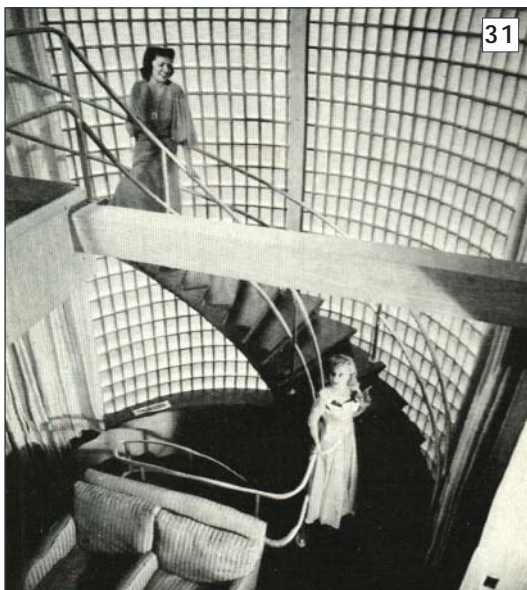

While modern architecture looked to maximize daylight, sometimes glare and shading became a problem. Bright interiors were beautiful, but privacy became a concern. Glass block addressed these issues, offering a solution for industrial, commercial, residential, and institutional structures alike.



An example of glass block in a stairwell of NSA Bethesda Building 3. (Photographer: Samantha Driscoll, 2014)



A common application of a large expanse of glass block in a research facility at NSF Indian Head Building 601A. (Photographer: Thomas Wright, 2014)



The diffused light and privacy of a glass block panel at NSF Bethesda Building 3. (Photographer: Samantha Driscoll, 2014)

ENDNOTES *The endnote numbers correspond to the numbers applied to the photographs within the visual guide.*

Steel

1. Detroit Steel Products Company, *Fenestra: The Blue Book of Steel Windows* (Detroit: Detroit Steel Products Company, 1926), 39.
2. Detroit Steel Products Company, *Fenestra: The Blue Book*, 6.
3. Detroit Steel Products Company, *Fenestra: The Blue Book*, 8.
4. Detroit Steel Products Company, *Fenestra: The Blue Book*, 8.
5. Detroit Steel Products Company, *Fenestra: The Blue Book*, 5.
6. David Lupton's Sons Company, *Lupton Steel Pivoted Windows* (Philadelphia: David Lupton's Sons Company, 1927), 11.
7. Truscon Steel Company, "Truscon Steel Windows," Internet Archive, accessed April 2014, <https://archive.org/details/TrusconSteelWindows>.
8. Henry Hope & Sons Ltd., *Casements and Steel Windows* (Birmingham, England: Henry Hope & Sons Ltd., 1904), 57.
9. Detroit Steel Products Company, *Fenestra: The Blue Book*, 11.
10. Sharon C. Park, "The Repair and Thermal Upgrading of Historic Steel Windows," in *Preservation Briefs*, No. 13 (Washington, D.C.: National Park Service, 1984), 4.
11. Detroit Steel Products Company, *Fenestra: The Blue Book*, 41.

12. Detroit Steel Products Company, *Fenestra: The Blue Book*, 73.
13. Park, “The Repair and Thermal Upgrading of Historic Steel Windows,” 2.
14. Detroit Steel Products Company, *Fenestra: The Blue Book*, 24.
15. Crittall Casement Window Company, “Crittall Solid Steel Reversible Windows,” in Catalog Nos. 1-24 (Detroit: Crittall Casement Window Company, 1924), 9.
16. Detroit Steel Products Company, *Fenestra: The Blue Book*, 15.
17. Detroit Steel Products Company, *Fenestra: The Blue Book*, 15.
18. Detroit Steel Products Company, *Fenestra: The Blue Book*, 15.
19. Detroit Steel Products Company, *Fenestra: The Blue Book*, 17.
20. Detroit Steel Products Company, *Fenestra: The Blue Book*, 17.
21. Truscon Steel Company, “Truscon Steel Windows.”
22. Detroit Steel Products Company, *Fenestra: The Blue Book*, 71.
23. Kerry Vautrot, Photographer, 2014.
24. Thomas Wright, Photographer, 2014.

25. Thomas Wright, Photographer, 2014.
26. David Lupton's Sons Company, *Lupton Steel Pivoted Windows*, 44.
27. David Lupton's Sons Company, *Lupton Steel Pivoted Windows*, 36.
28. Detroit Steel Products Company, *Fenestra: The Blue Book*, 71.
29. Charles E. Fisher, "Aluminum Replacements for Steel Industrial Sash," in *Windows*, No. 12, Preservation Tech Notes (Washington, D.C.: National Park Service, 1986), 3.

Corrugated Wire Glass

1. Sergeant Wire Glass Corporation, "Glass for Controlled Light" (Sergeant, Pennsylvania: Sergeant Wire Glass Corporation, 1940), 4.
2. Pennsylvania Wire Glass Company, "Description of Solid Wire Glass" (Philadelphia: Franklin Hodges Company, 1918), 3.
3. Pennsylvania Wire Glass Company, "Description of Solid Wire Glass," 11.
4. Hires Turner Glass Company, "Corrugated Wire Glass for Industrial Buildings" (Philadelphia: Hires Turner Glass Company, n.d.), 14.
5. Hires Turner Glass Company, "Corrugated Wire Glass for Industrial Buildings," 14.
6. Pennsylvania Wire Glass Company, "Description of Solid Wire Glass," 15.
7. Hires Turner Glass Company, "Corrugated Wire Glass" (Philadelphia: Hires Turner Glass Company, 1924), 2.
8. Hires Turner Glass Company, "Corrugated Wire Glass for Industrial Buildings," 6.
9. Hires Turner Glass Company, "Corrugated Wire Glass for Industrial Buildings," 11.

10. Hires Turner Glass Company, “Corrugated Wire Glass for Industrial Buildings,” 12.
11. Hires Turner Glass Company, “Corrugated Wire Glass,” 40.
12. Pennsylvania Wire Glass Company, “Original Solid Corrugated Wire Glass Skylights, Sawtooth and Side Wall Construction” (Philadelphia: Pennsylvania Wire Glass Company, 1940), 3.
13. Hires Turner Glass Company, “Corrugated Wire Glass for Industrial Buildings,” 7.
14. Hires Turner Glass Company, “Corrugated Wire Glass,” 4.
15. Hires Turner Glass Company, “Corrugated Wire Glass,” 12.
16. Hires Turner Glass Company, “Corrugated Wire Glass,” 21.
17. Hires Turner Glass Company, “Corrugated Wire Glass,” 53.
18. Hires Turner Glass Company, “Corrugated Wire Glass,” 23.
19. Hires Turner Glass Company, “Corrugated Wire Glass,” 22.
20. Hires Turner Glass Company, “Corrugated Wire Glass,” 20.
21. Hires Turner Glass Company, “Glass for Every Industry” (Philadelphia: Hires Turner Glass Company, 1919), 5.
22. Pennsylvania Wire Glass Company, “Original Solid Corrugated Wire Glass,” 20.
23. Pennsylvania Wire Glass Company, “Original Solid Corrugated Wire Glass,” 20.
24. Hires Turner Glass Company, “Corrugated Wire Glass,” 41.
25. Pennsylvania Wire Glass Company, “Pennsylvania Corrugated Glass” (Philadelphia: Pennsylvania Wire Glass Company, 1953), 2.

26. Hires Turner Glass Company, “Corrugated Wire Glass,” 26.
27. Pennsylvania Wire Glass Company, “Original Solid Corrugated Wire Glass,” 1.
28. Pennsylvania Wire Glass Company, “Original Solid Corrugated Wire Glass,” 1.
29. Hires Turner Glass Company, “Corrugated Wire Glass for Industrial Buildings,” 28.
30. Hires Turner Glass Company, “Corrugated Wire Glass,” 19.
31. Hires Turner Glass Company, “Glass for Every Industry,” 4.
32. Kerry Vautrot, Photographer, 2014.
33. Kerry Vautrot, Photographer, 2014.
34. Kerry Vautrot, Photographer, 2014.

Glass Block

1. Pittsburgh Corning Corporation, *PC Glass Blocks* (Pittsburgh: Pittsburgh Corning Corporation, 1940), 16.
2. Owens-Illinois Glass Company, *The Glass Block Building: A Century of Progress* (Toledo, Ohio: Owens-Illinois Glass Company, 1933), 2.
3. Owens-Illinois Glass Company, *The Glass Block Building*, 2.
4. Owens-Illinois Glass Company, *The Glass Block Building*, 2.
5. Pittsburgh Corning Corporation, “Pittsburgh Corning Glass Blocks: Combine the Light-Transmitting Values of Glass with the Insulating Values of a Masonry Wall” (Pittsburgh: Pittsburgh Corning Corporation, 1939), 2-3.

6. Pittsburgh Corning Corporation, “Make the Most of Daylight with PC Functional Glass Blocks,” (Pittsburgh: Pittsburgh Corning Corporation, 1949), 3.
7. Owens-Illinois Glass Company, *Insulux Glass Block for Greater Comfort and Beauty in the Home* (Toledo, Ohio: Owens-Illinois Glass Company, 1939), 2.
8. Owens-Illinois Glass Company, *Owens-Illinois Insulux Glass Block 1943* (Toledo, Ohio: Owens-Illinois Glass Company, 1943), 4.
9. Pittsburgh Corning Corporation, *PC Glass Blocks*, 17.
10. Pittsburgh Corning Corporation, “Pittsburgh Corning Glass Blocks: Combine the Light-Transmitting Values of Glass with the Insulating Values of a Masonry Wall,” 7.
11. Pittsburgh Corning Corporation, “Pittsburgh Corning Glass Blocks: Combine the Light-Transmitting Values of Glass with the Insulating Values of a Masonry Wall,” 29.
12. Owens-Illinois Glass Company, *Owens-Illinois Insulux Glass Block 1943*, 5.
13. Pittsburgh Corning Corporation, “Pittsburgh Corning Glass Blocks: Illustrating Many and Varied Uses of PC Glass Block Construction in Commercial and Public Buildings, Schools and Hospitals,” (Pittsburgh: Pittsburgh Corning Corporation, 1945), 7.
14. Owens-Illinois Glass Company, *Owens-Illinois Insulux Glass Block 1943*, 9.
15. Pittsburgh Corning Corporation, “Pittsburgh Corning Glass Blocks: Illustrating Many and Varied Uses of PC Glass Block Construction,” 5.
16. Pittsburgh Corning Corporation, “Pittsburgh Corning Glass Blocks: Illustrating Many and Varied Uses of PC Glass Block Construction,” 5.
17. Pittsburgh Corning Corporation, “Pittsburgh Corning Glass Blocks: Illustrating Many and Varied Uses of PC Glass Block Construction,” 5.

18. Owens-Illinois Glass Company, *Owens-Illinois Insulux Glass Block 1943*, 3.
19. Owens-Illinois Glass Company, *Owens-Illinois Insulux Glass Block 1943*, 3.
20. Pittsburgh Corning Corporation, *PC Glass Blocks: A Modular Product* (Pittsburgh: Pittsburgh Corning Corporation, 1947), 6.
21. Pittsburgh Corning Corporation, *PC Glass Blocks: A Modular Product*, 6.
22. Pittsburgh Corning Corporation, *PC Glass Blocks: A Modular Product*, 5.
23. Owens-Illinois Glass Company, *Owens-Illinois Insulux Glass Block 1943*, 1.
24. Pittsburgh Corning Corporation, *PC Glass Blocks*, 9.
25. Pittsburgh Corning Corporation, *PC Glass Blocks*, 9.
26. Pittsburgh Corning Corporation, *PC Glass Blocks*, 12.
27. Pittsburgh Corning Corporation, “Pittsburgh Corning Glass Blocks: Illustrating Many and Varied Uses of PC Glass Block Construction,” 3.
28. Pittsburgh Corning Corporation, “Pittsburgh Corning Glass Blocks: Illustrating Many and Varied Uses of PC Glass Block Construction,” 3.
29. Owens-Illinois Glass Company, *Insulux Glass Block for Greater Comfort and Beauty in the Home*, 14.
30. Owens-Illinois Glass Company, *Insulux Glass Block for Greater Comfort and Beauty in the Home*, 4.
31. Owens-Illinois Glass Company, *Insulux Glass Block for Greater Comfort and Beauty in the Home*, 4.
32. Pittsburgh Corning Corporation, *PC Glass Blocks*, 8.
33. Samantha Driscoll, Photographer, 2014.

34. Thomas Wright, Photographer, 2014.

35. Samantha Driscoll, Photographer, 2014.

BIBLIOGRAPHY

Steel

Crittall Casement Window Company

1924 “Crittall Solid Steel Reversible Windows.” Catalog Nos. 1-24. Crittall Casement Window Company, Detroit, Michigan.

David Lupton’s Sons Company

1927 *Lupton Steel Pivoted Windows*. Catalogue No. 12. David Lupton’s Sons Company, Philadelphia, Pennsylvania.

Detroit Steel Products Company

1926 *Fenestra: The Blue Book of Steel Windows*. Detroit Steel Products Company, Detroit, Michigan.

Fisher, Charles E.

1986 “Aluminum Replacements for Steel Industrial Sash.” *Windows*, No. 12, Preservation Tech Notes. National Park Service, Washington, D.C.

Henry Hope & Sons Ltd.

1904 *Casements and Steel Windows*. Henry Hope & Sons, Birmingham, England.

1926 *Hopes Standard Steel Windows*. Henry Hope & Sons, London, England.

Park, Sharon C.

1984 “The Repair and Thermal Upgrading of Historic Steel Windows.” *Preservation Briefs*, No. 13. National Park Service, Washington, D.C.

Truscon Steel Company

1920 “Truscon Steel Windows.” <https://archive.org/details/TrusconSteelWindows>, accessed April 2014.

Vautrot, Kerry

2014 Cultural Resources Manager. Photographs on file at A.D. Marble & Company, Conshohocken, Pennsylvania.

Wright, Thomas

2014 Cultural and NEPA Program Manager. Photographs on file at A.D. Marble & Company, Conshohocken, Pennsylvania.

Vautrot, Kerry

2014 Cultural Manager. Photographs on file at A.D. Marble & Company, Conshohocken, Pennsylvania.

Corrugated Wire Glass

Hires Turner Glass Company

n.d. "Corrugated Wire Glass for Industrial Buildings." Hires Turner Glass Company, Philadelphia, Pennsylvania.

1919 "Glass for Every Industry." Hires Turner Glass Company, Philadelphia, Pennsylvania.

1924 "Corrugated Wire Glass." Hires Turner Glass Company, Philadelphia, Pennsylvania.

Pennsylvania Wire Glass Company

1918 "Description of Solid Wire Glass." Franklin Hodges Company, Philadelphia, Pennsylvania.

1940 "Original Solid Corrugated Wire Glass Skylights, Sawtooth and Side Wall Construction." Pennsylvania Wire Glass Company, Philadelphia, Pennsylvania.

1953 "Pennsylvania Corrugated Glass." Pennsylvania Wire Glass Company, Philadelphia, Pennsylvania.

Sergeant Wire Glass Corporation

1940 “Glass for Controlled Light.” Sergeant Wire Glass Corporation. Sergeant, Pennsylvania.

Vautrot, Kerry

2014 Cultural Manager. Photographs on file at A.D. Marble & Company, Conshohocken, Pennsylvania.

Glass Block

Driscoll, Samantha

2014 Architectural Historian. Photographs on file at A.D. Marble & Company, Conshohocken, Pennsylvania.

Owens-Illinois Glass Company

1933 *The Glass Block Building: A Century of Progress*. Owens-Illinois Glass Company, Toledo, Ohio.

1939 *Insulux Glass Block for Greater Comfort and Beauty in the Home*. Owens-Illinois Glass Company, Toledo, Ohio.

1943 *Owens-Illinois Insulux Glass Block 1943*. Owens-Illinois Glass Company, Toledo, Ohio.

1945 *Insulux Glass Block: A Product of the Owens-Illinois Glass Company*. Owens-Illinois Glass Company, Toledo, Ohio.

Pittsburgh Corning Corporation

1939 “Pittsburgh Corning Glass Blocks: Combine the Light-Transmitting Values of Glass with the Insulating Values of a Masonry Wall.” Brochure. Pittsburgh Corning Corporation, Pittsburgh, Pennsylvania.

1940 *PC Glass Blocks*. Pittsburgh Corning Corporation, Pittsburgh, Pennsylvania.

1945 “Pittsburgh Corning Glass Blocks: Illustrating Many and Varied Uses of PC Glass Block Construction in Commercial and Public Buildings, Schools and Hospitals.” Brochure. Pittsburgh Corning Corporation, Pittsburgh, Pennsylvania.

1947 *PC Glass Blocks: A Modular Product*. Pittsburgh Corning Corporation, Pittsburgh, Pennsylvania.

1949 “Make the Most of Daylight with PC Functional Glass Blocks.” Brochure. Pittsburgh Corning Corporation, Pittsburgh, Pennsylvania.



375 East Elm Street, Suite 101
Conshohocken, PA 19428



Naval Facilities Engineering Command Mid-Atlantic
9742 Maryland Avenue
Norfolk, VA 23511



DoD Legacy Resource Management Program
3400 Defense Pentagon
Room 5C646
Washington, D.C. 20301