

Perspectives on Management Systems



Colonel Art Kaminski
Assistant for Safety, Health & Fire
Office of the Deputy Under Secretary of Defense
(Installations & Environment)
September 20, 2005



President's Management Agenda

- Improved Financial Performance
- Budget & Performance Integration
- Competitive Sourcing
- Expanded Electronic Government
- Strategic Management of Human Capital



SOH Imperative to Support the President's Management Agenda

- Preserve Human Capital
- Reduce Liability
- Improve Efficiency / Effectiveness
- Comply
- Continuous Improvement
 - President's SHARE program
- Risk Management



SOH Focus

- Eliminate Injury & Illness / Eliminate “mishaps”



Dissecting a Mishap

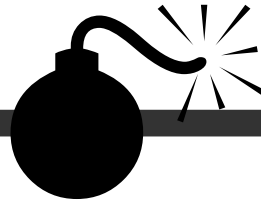



Dissecting a Mishap (Potential Mission Impact)

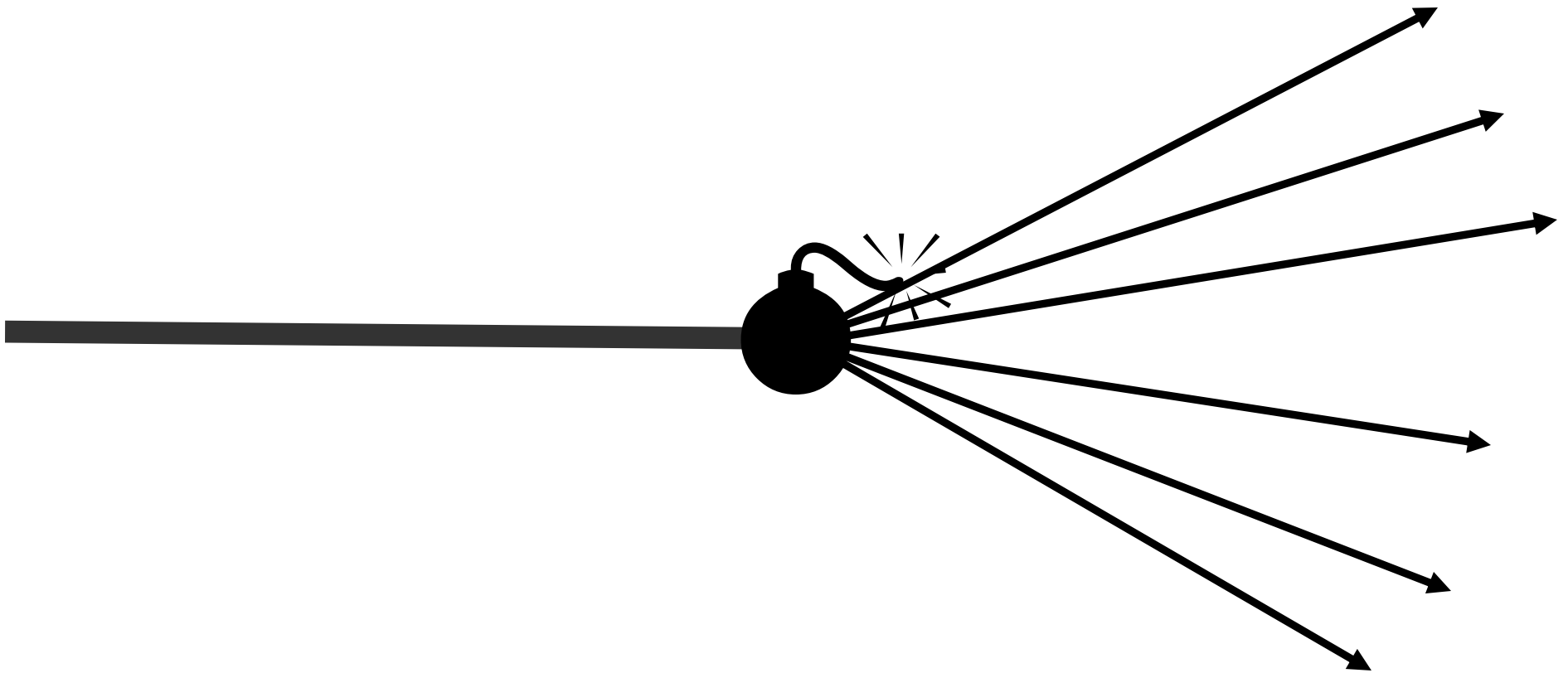



Dissecting a Mishap

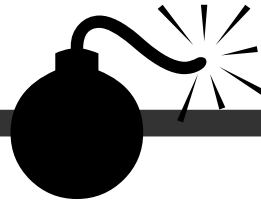



Dissecting a Mishap

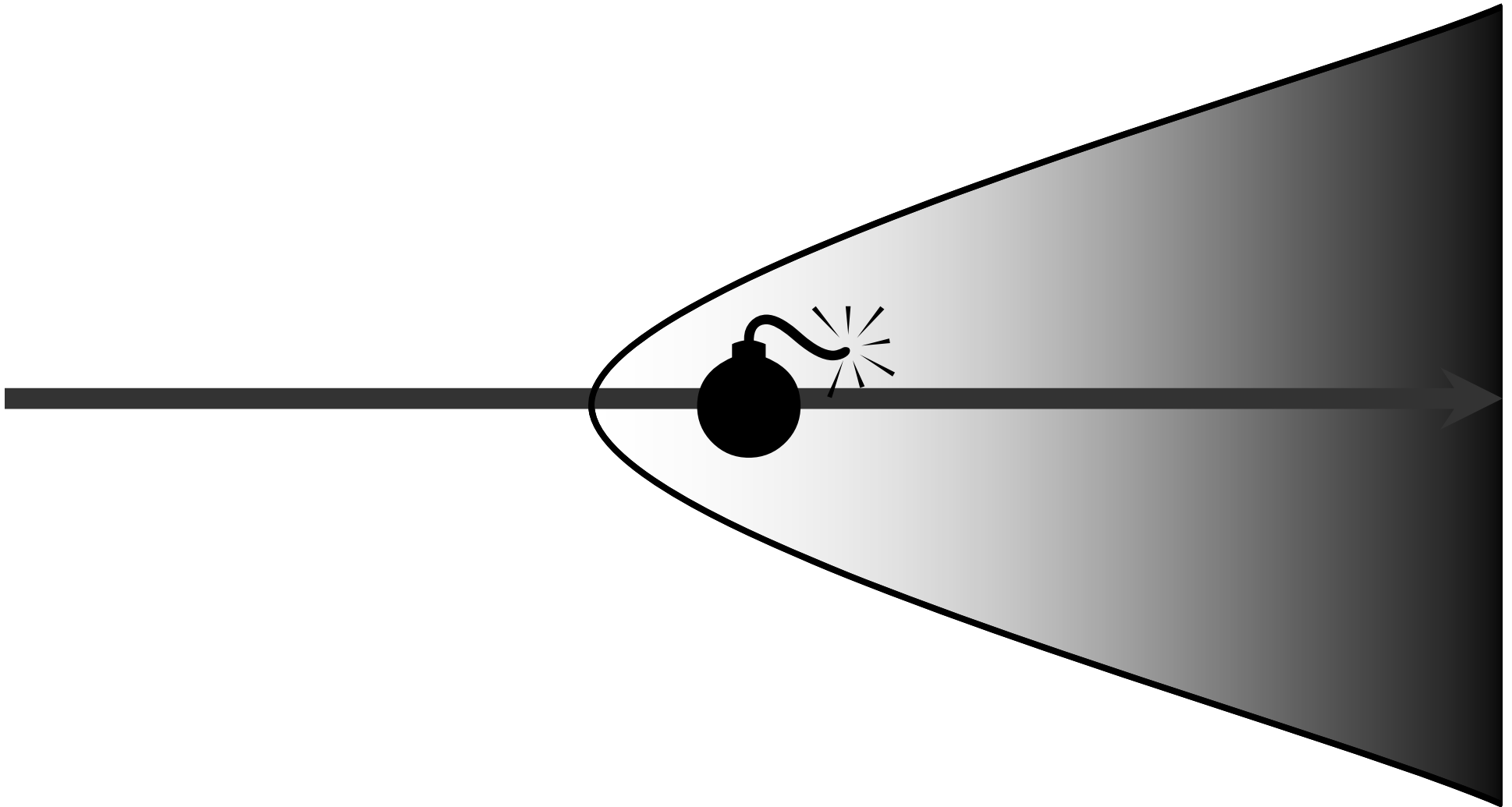



Dissecting a Mishap

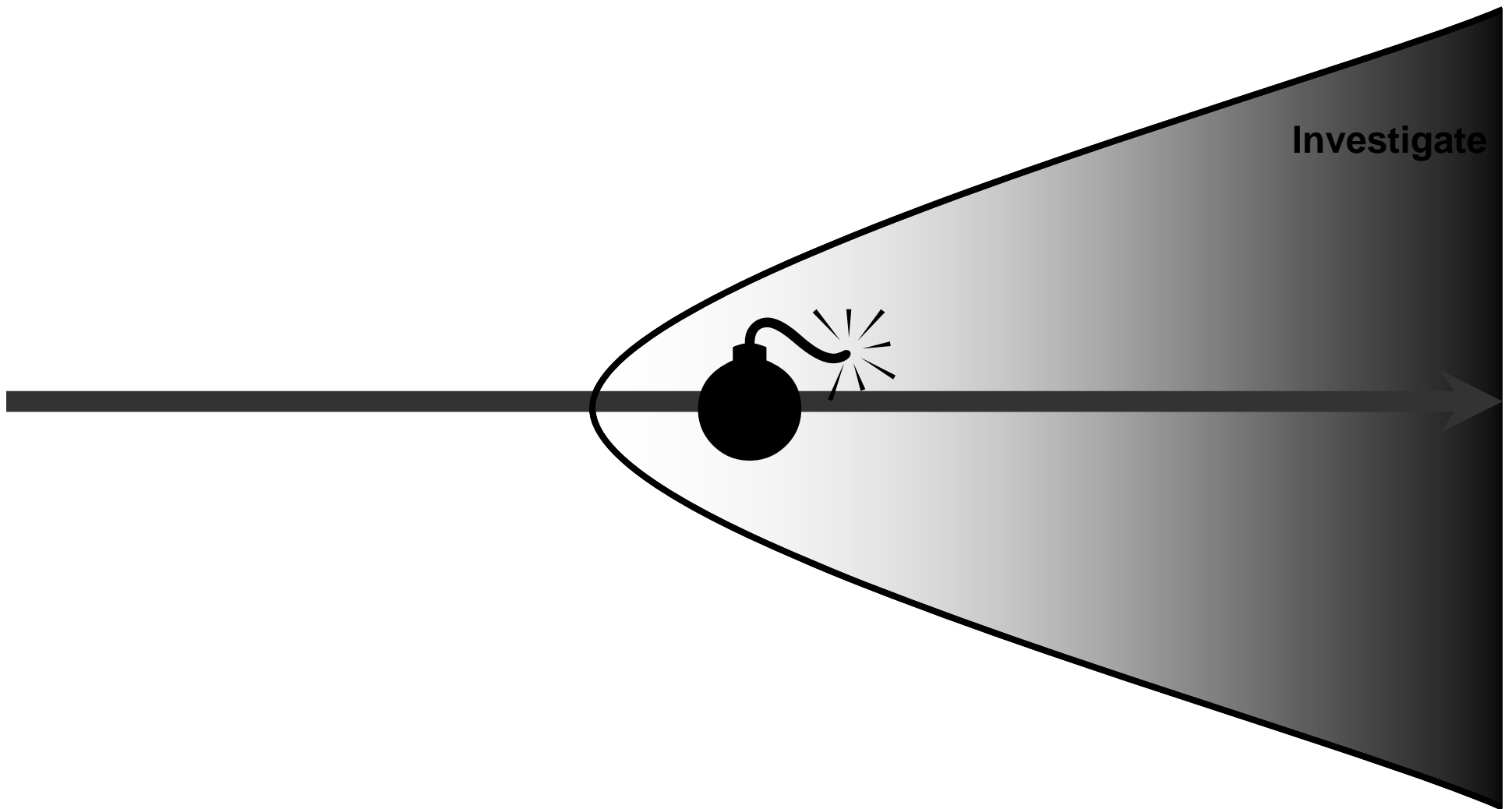



Dissecting a Mishap

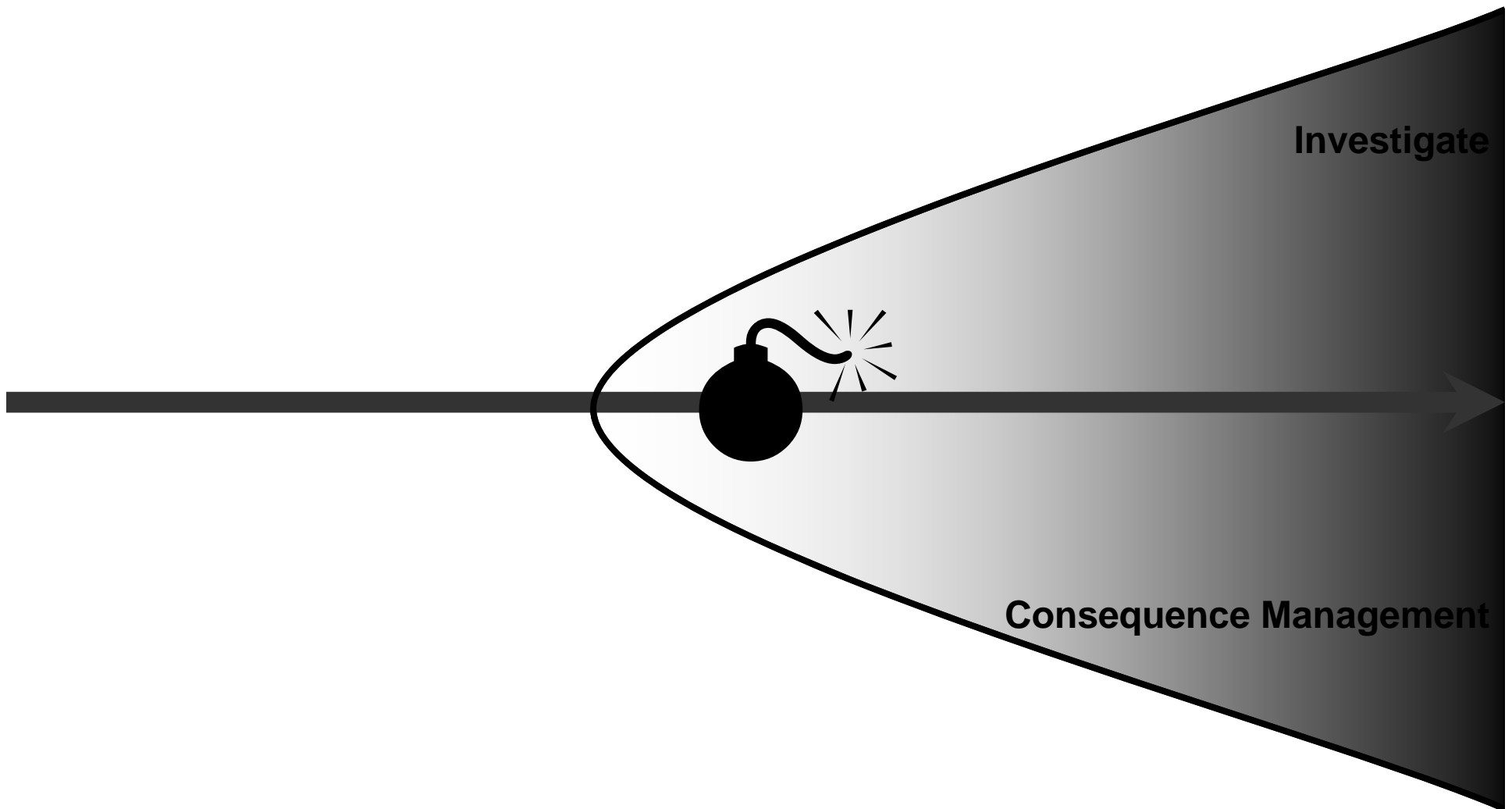



Dissecting a Mishap

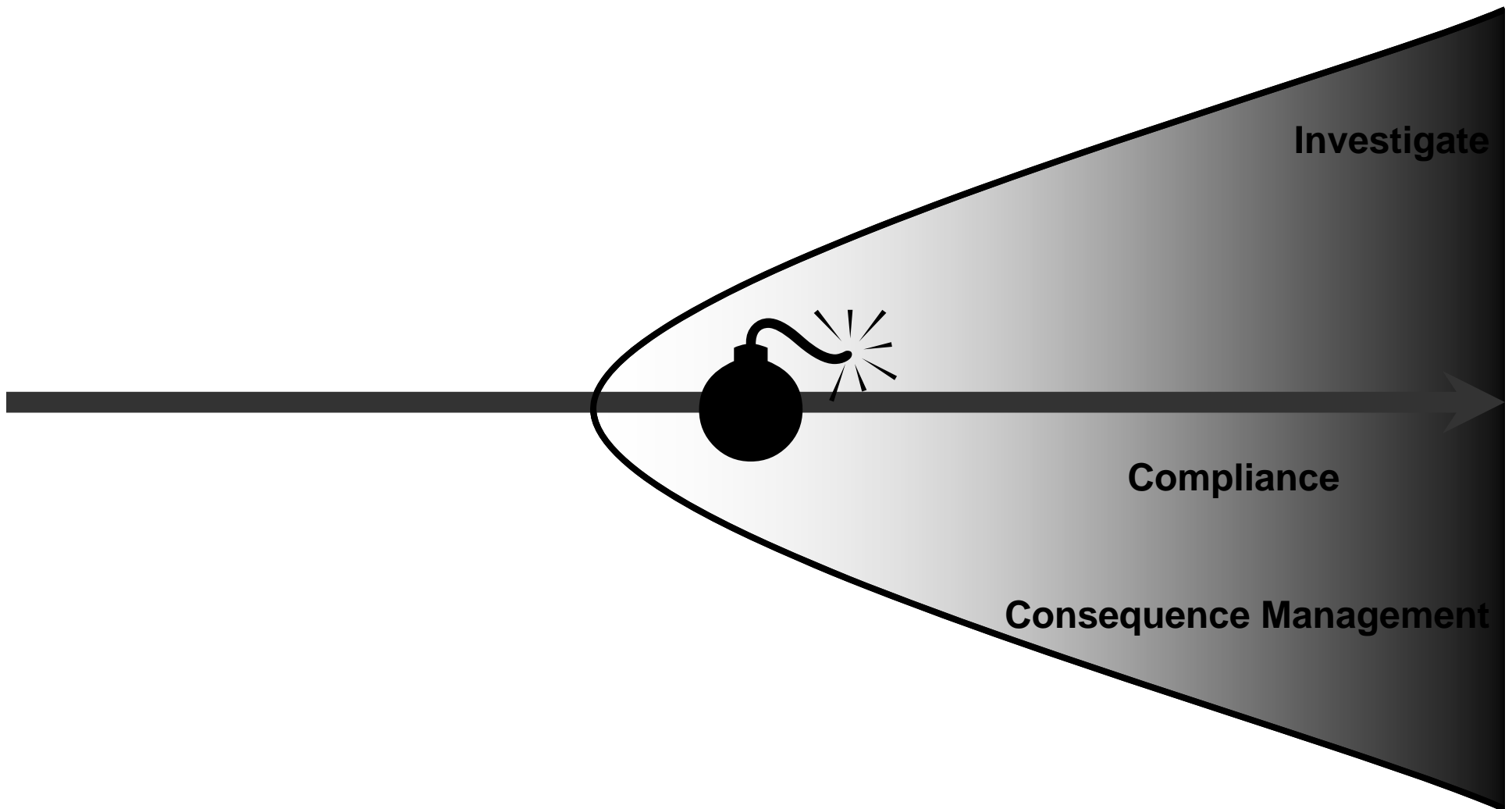



Dissecting a Mishap

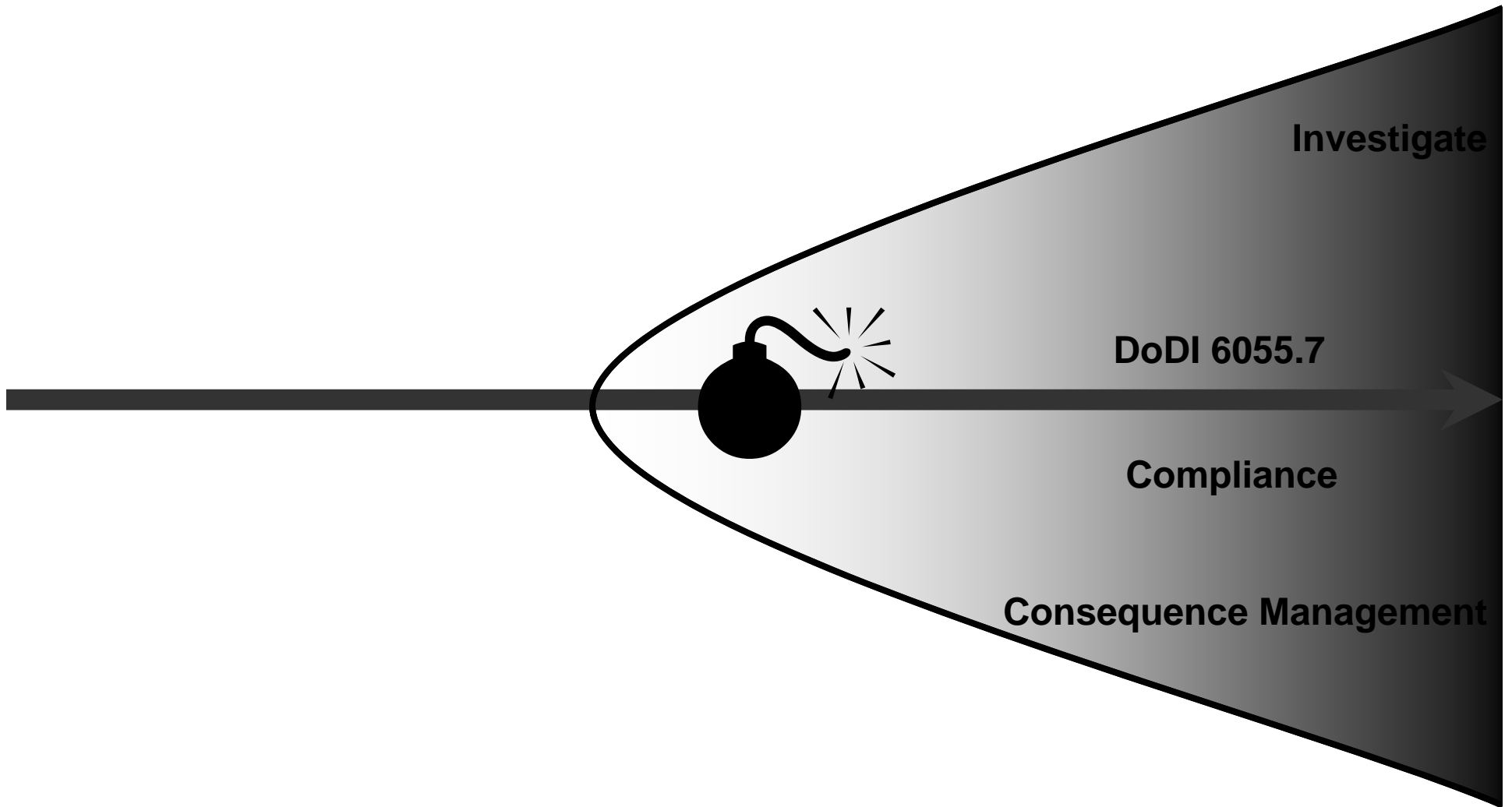



Dissecting a Mishap

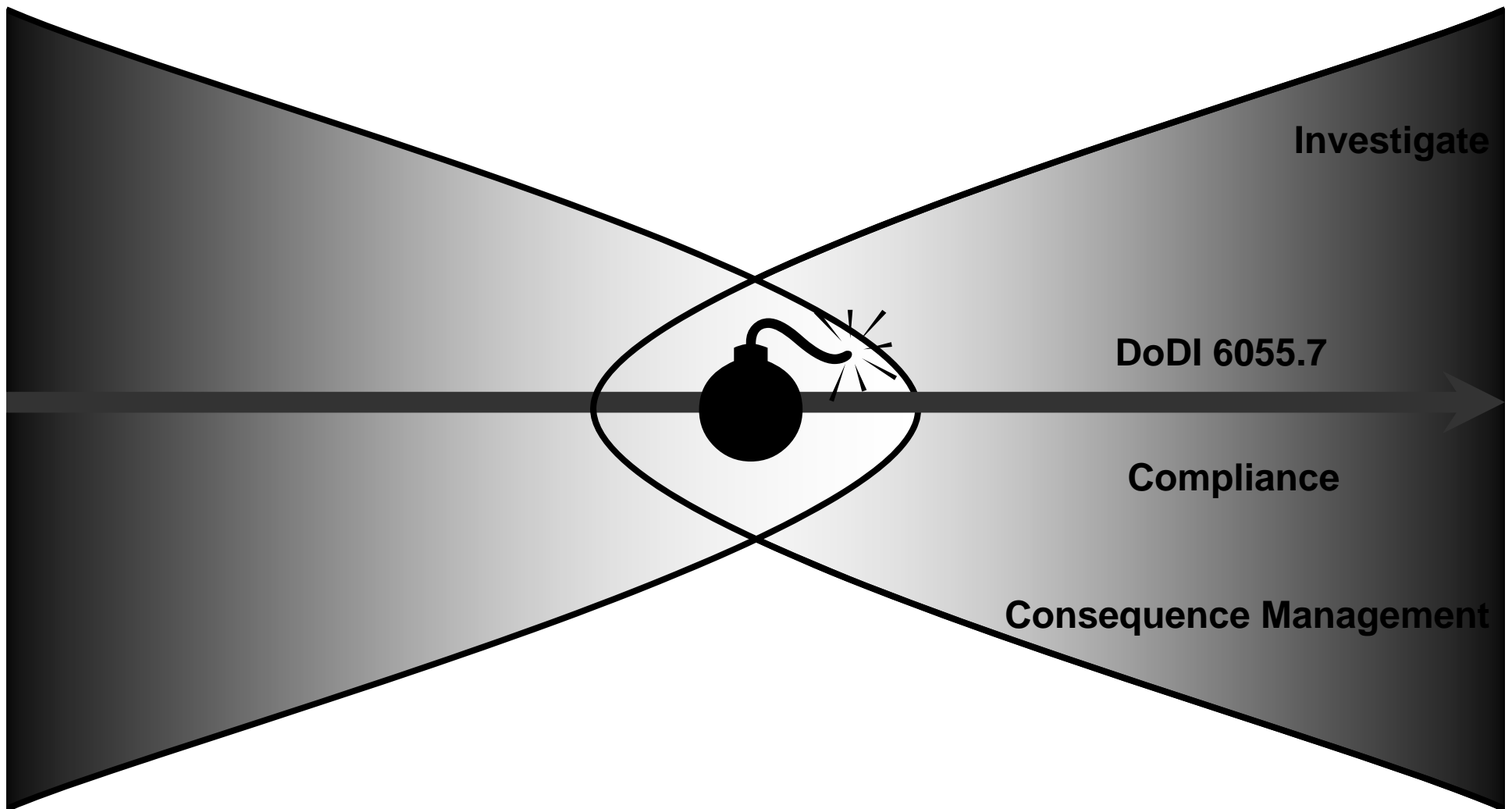



Dissecting a Mishap

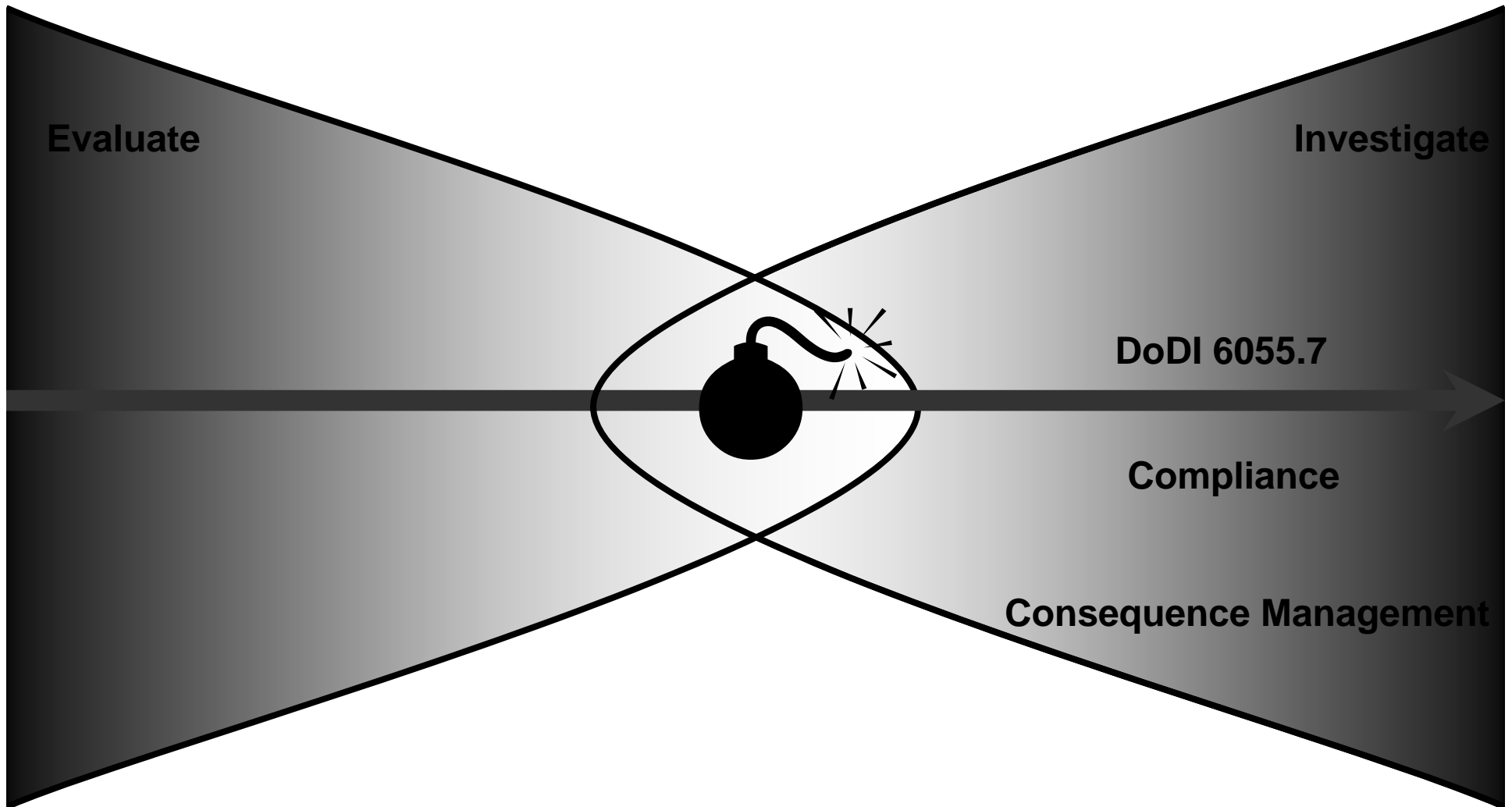



Dissecting a Mishap

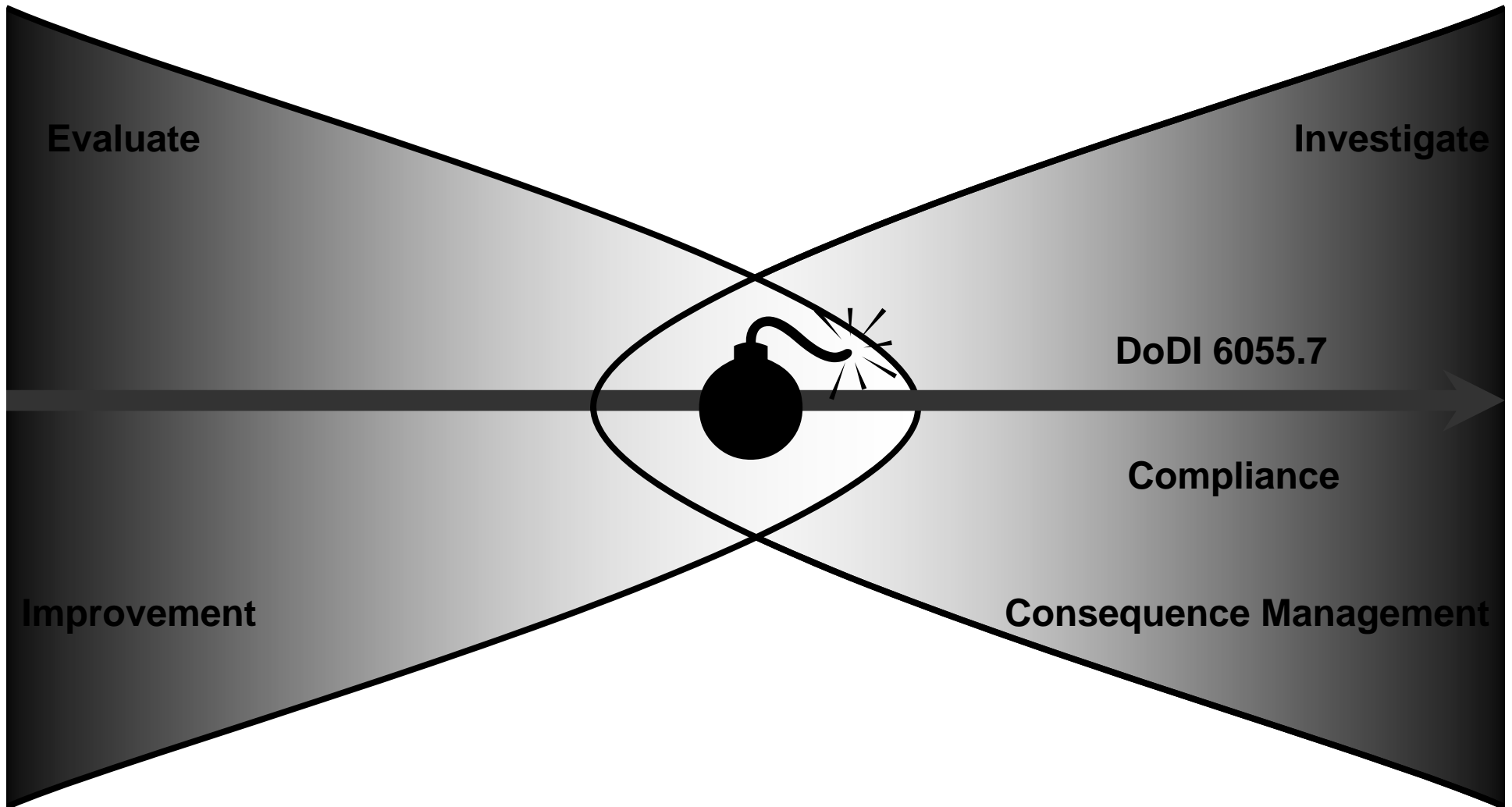



Dissecting a Mishap

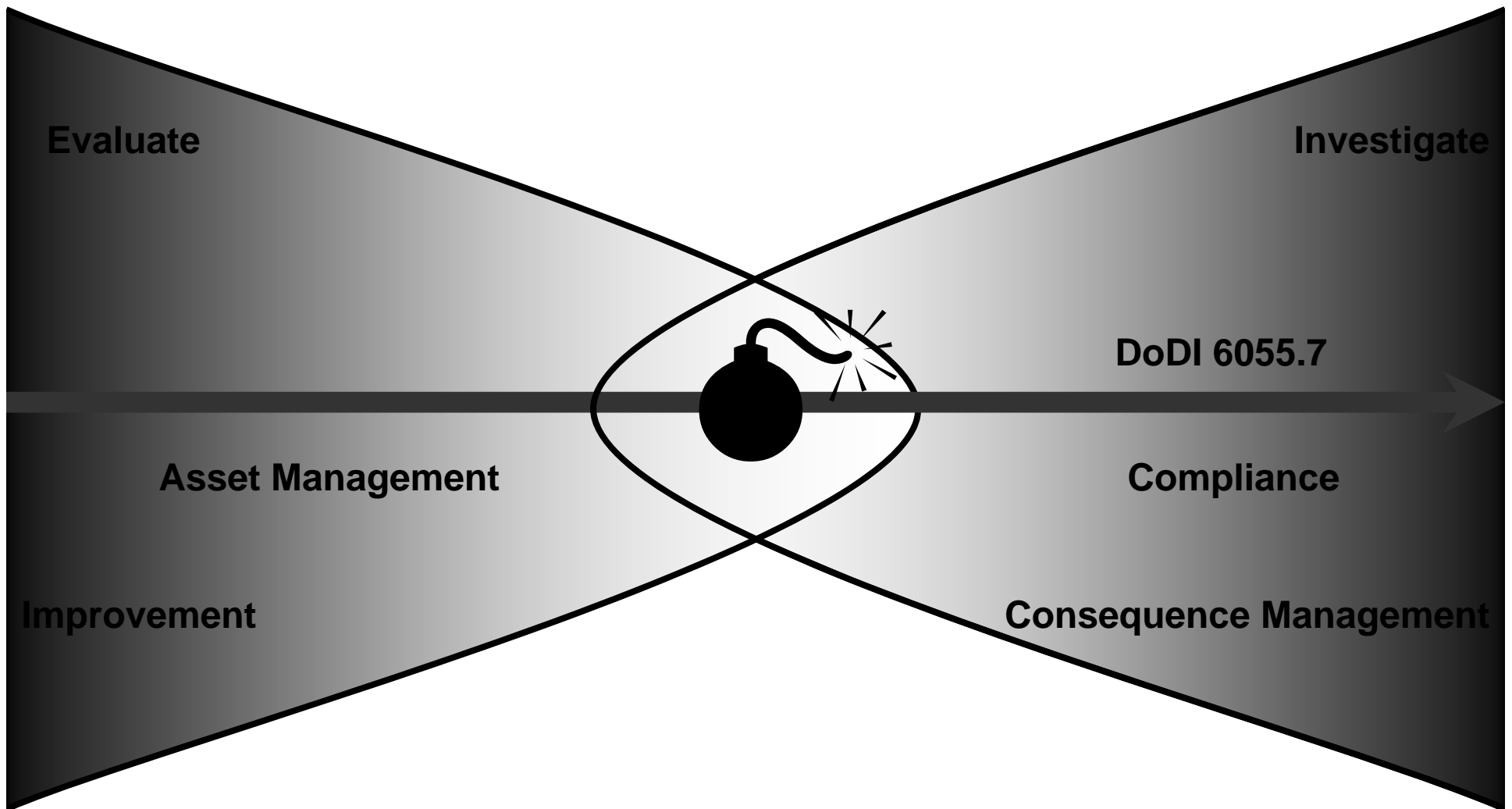



Dissecting a Mishap

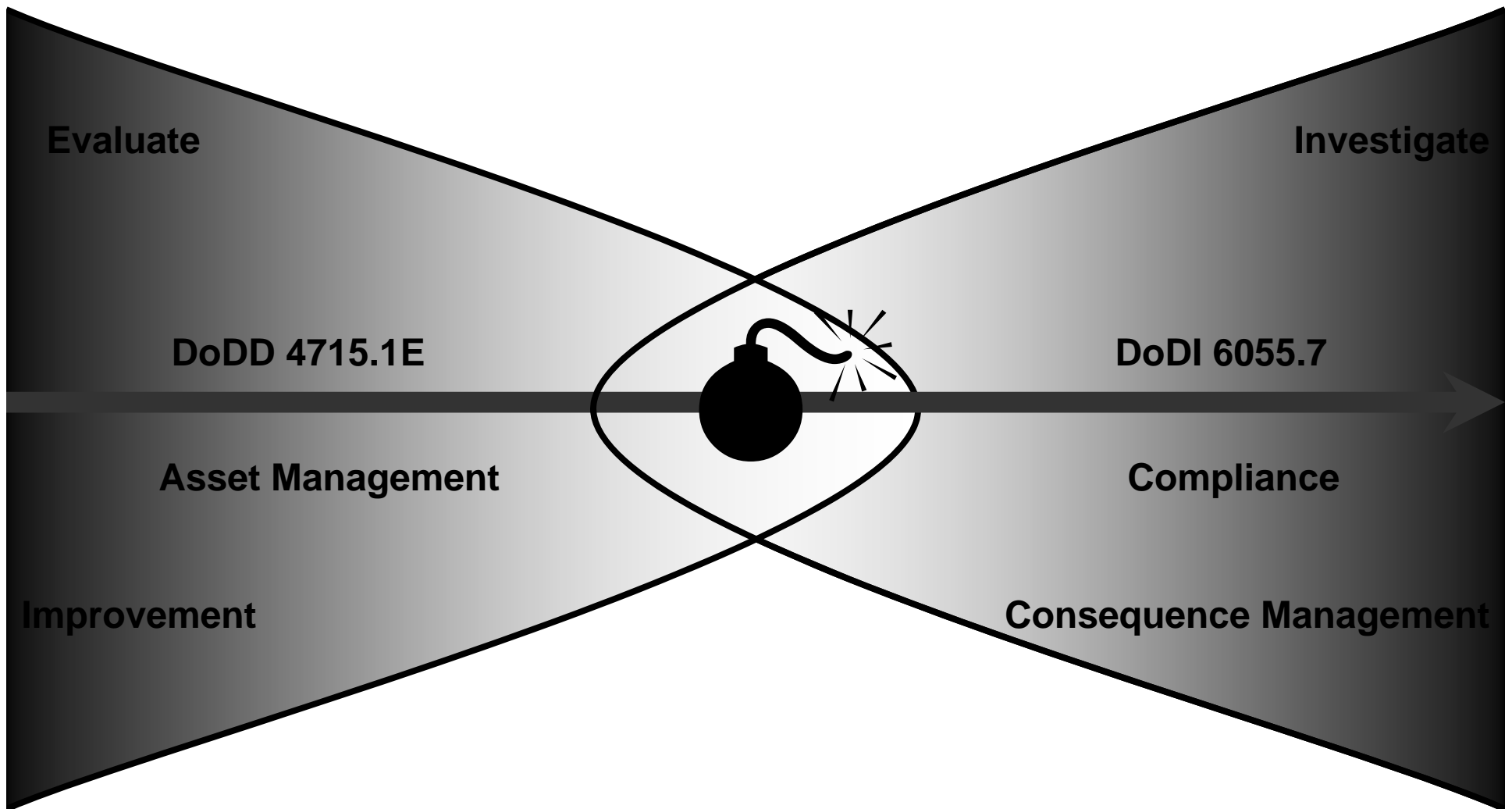



Dissecting a Mishap

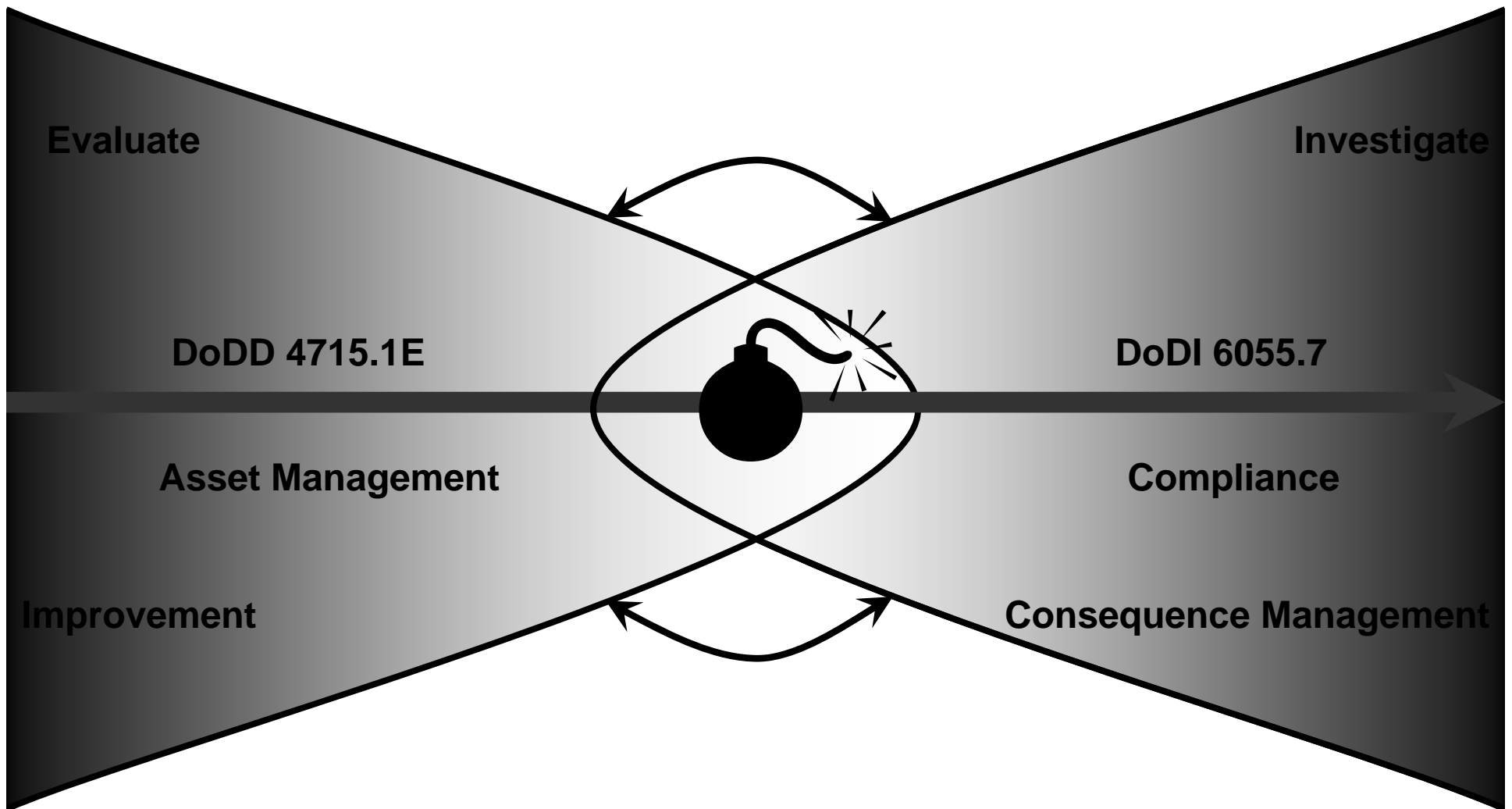



Dissecting a Mishap

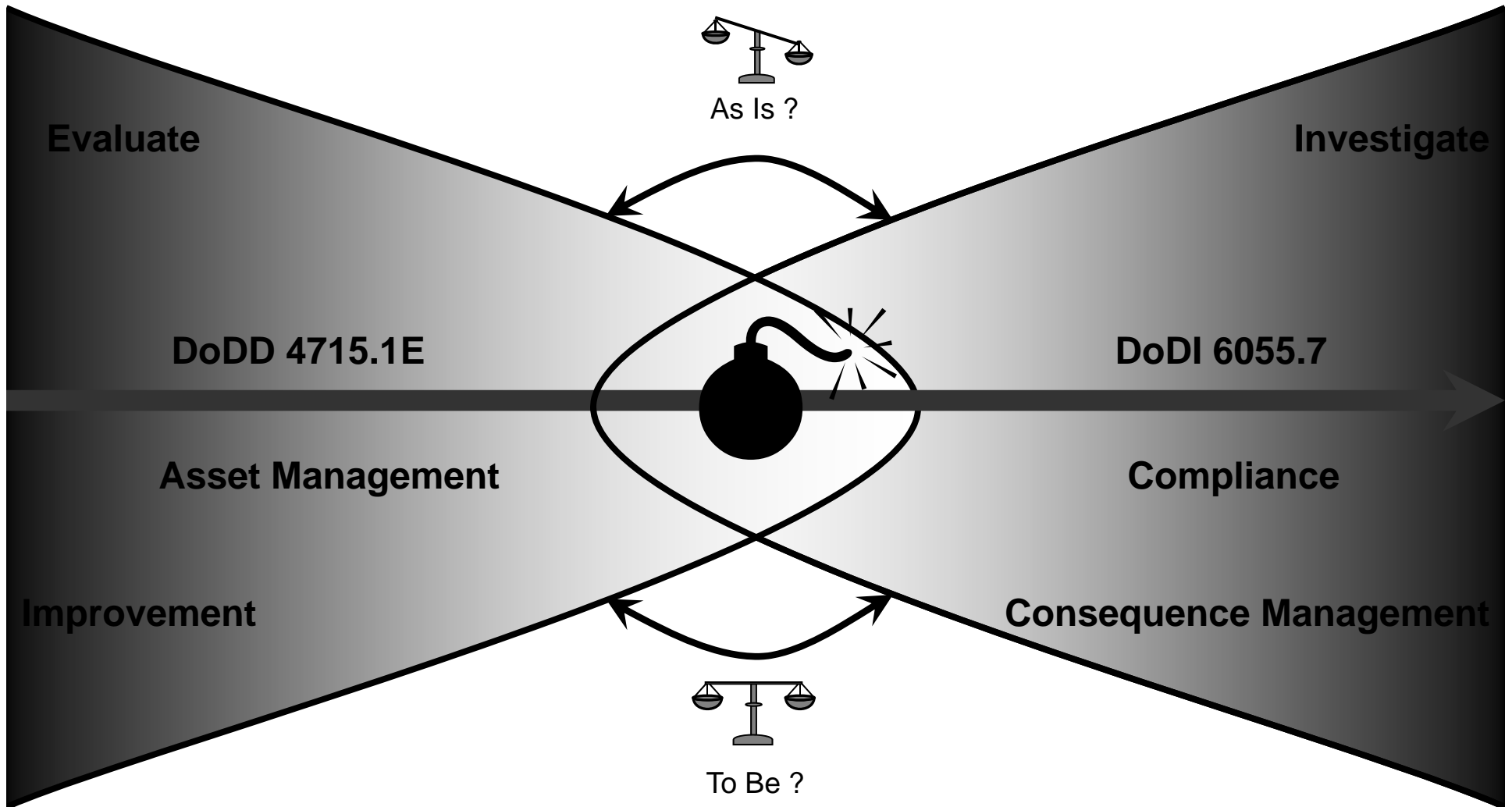



Achieving Balance - Continual Improvement

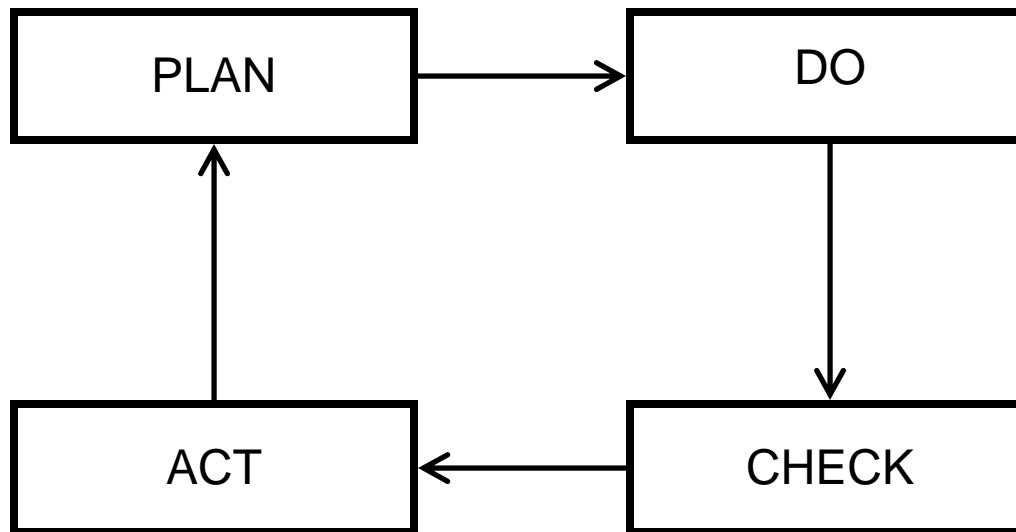



Management System

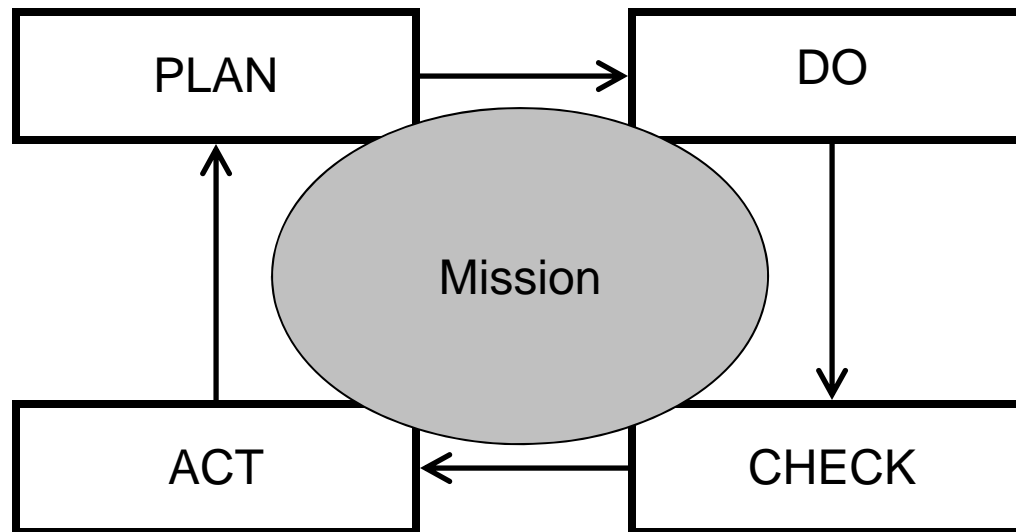

A set of interrelated elements that establish and/or support (SHE) policy and objectives, and mechanisms to achieve those objectives in order to continually improve performance.



SOH Management System Models

- ANSI Z.10
- OHSAS 18000
- ISO 14000 like
- VPP
 - Challenge Program



Point of Emphasis

A management system
is not a computer system



Management System: Expanded View

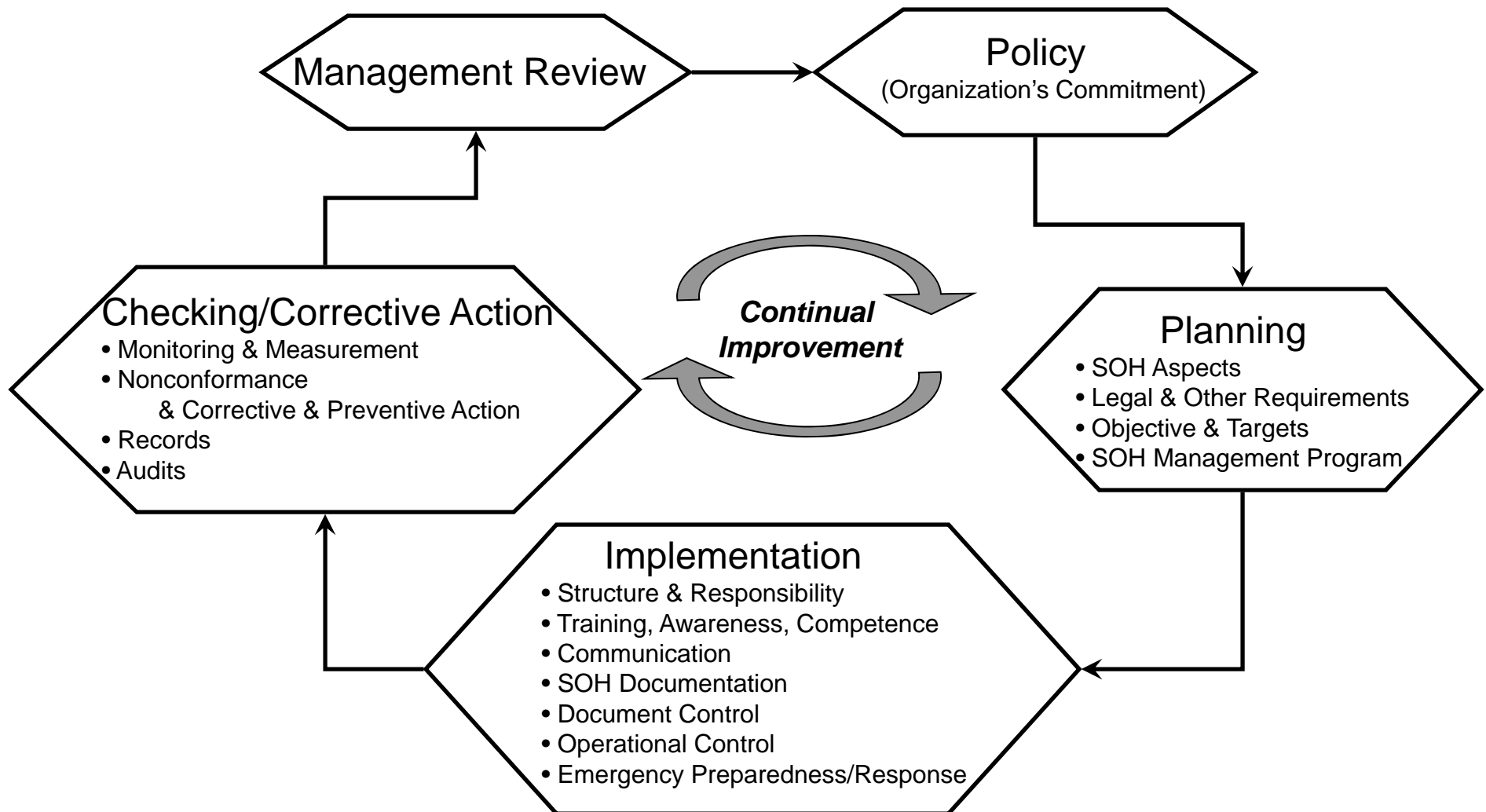



Point of Emphasis

A management system
is not a computer system



Management Systems

- DoD Policy (DoDD 4715.1E)
- SOH Integration (a gear not a speed bump)
 - With Mission
 - Within SOH & ESOH
- A path to “level 4”
- The right thing to do



Point of Emphasis

A management system
is not a computer system



Implementation Milestones/Metrics

- Expect sign-out Nov-Dec 2005
 - Current DRAFT
 - ID “appropriate” installations (denominator)
 - Policy Statement (% of Appropriate Installations)
 - Self Assessment (% of Appropriate Installations)
 - Written Plan Self (% of Appropriate Installations)
 - Training (...)
 - ...
 - Management Review (% of Appropriate Installations)
- OR**
- ID “appropriate” installations (denominator)
 - Enrolled in Challenge Program
 - Progress in Challenge stages



ESOH Management Systems: Building a Foundation for Excellence

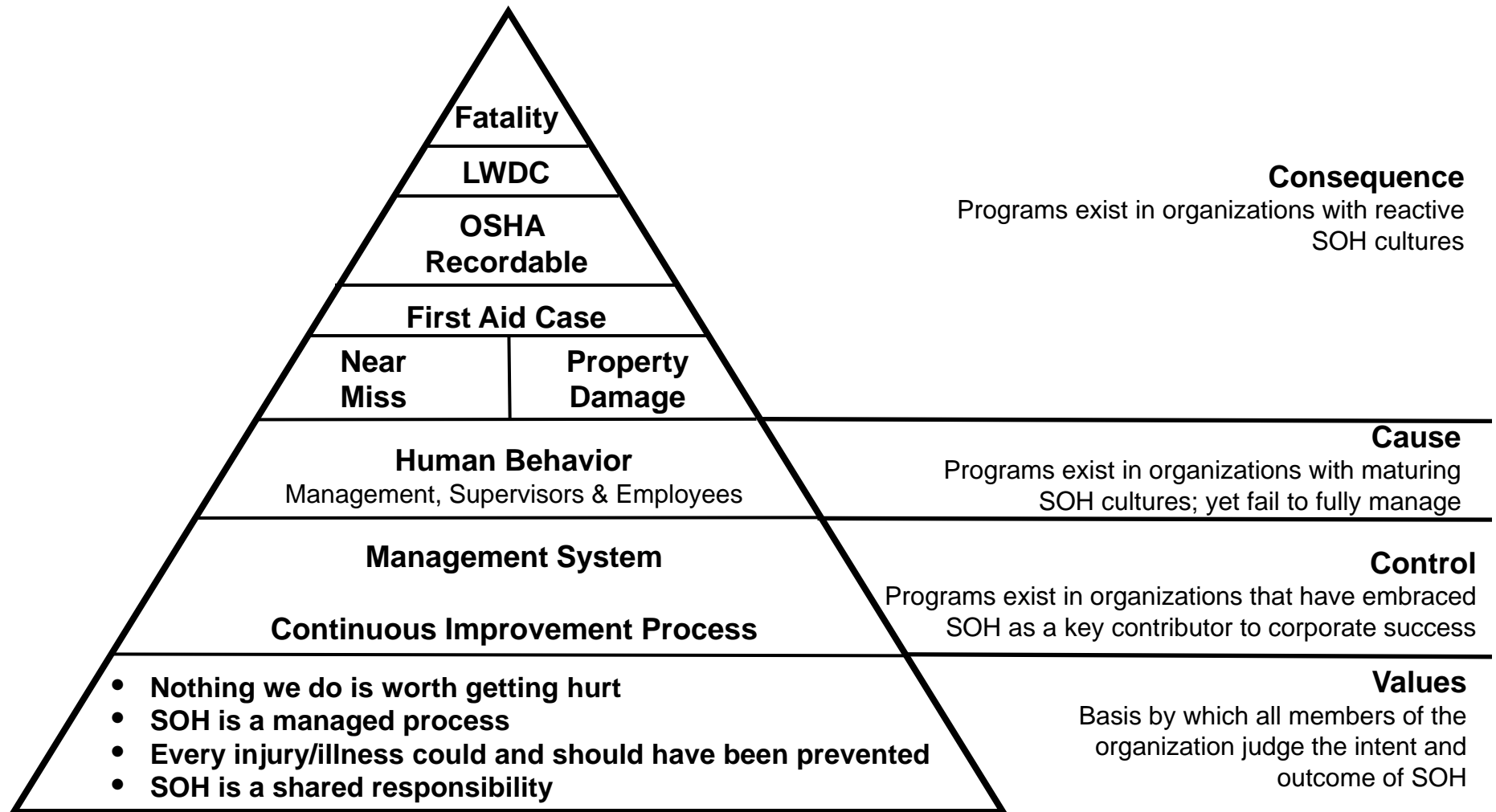

© 2002 National Safety Council

Perspectives on Management Systems



Colonel Art Kaminski
Assistant for Safety, Health & Fire
Office of the Deputy Under Secretary of Defense
(Installations & Environment)
September 20, 2005